

ARTINOX

OUTDOOR
WORKSTATION SINKS

OUTDOOR
WORKSTATION
SINKS

HISTORY AND PASSION

Artinox was founded in 1985 by Mario Zanardo in Conegliano in one of the most important Italian industrial areas known for the stainless steel processing. Dedicated to the high-end kitchen market, all our collections are designed and produced with passion in our factory and distributed all over the world.



QUALITY AND SUSTAINABILITY

Beyond the intrinsic qualities of the raw material, we are committed to the implementation of our environmental management system. At Artinox we have been using the control of all processes to guarantee the maximum result of the services offered - ISO 9001 certification - and taking care of the factors interacting with the environment - ISO 14001 -.



FUNCTIONAL DESIGN

At Artinox we revolutionize the time spent in the kitchen. All of the Workstations are integrated into the worktop becoming one. The sliding system allows the positioning and the sliding of infinite accessories dedicated to multiple functions; from grids to supports, from chopping boards to containers, these accessories are made to last and to serve with a simple gesture.



OUR STAINLESS STEEL

Our stainless steel AISI 304 and AISI 316 it's used in both domestic and professional environments while meeting all industry standards. It's extremely easy to clean thanks to the non-porous surface, which results in a high antibacterial property. Our steel is unalterable over time, is made up of over 70% recycled materials and is 100% recyclable.

Artinox has chosen AISI 316 L for the OUTDOOR collection, a complete range of products dedicated for the outdoors. This stainless steel is a specialty material, typically used in marine and surgical environments. It offers very high resistance to saltiness as well as food acids.

DETAILS THAT MAKE THE DIFFERENCE

Dedicated accessories

The stainless steel accessories, always thickly produced in our factories, are dishwasher safe.
The chopping boards are made of wood or non-toxic polyethylene.

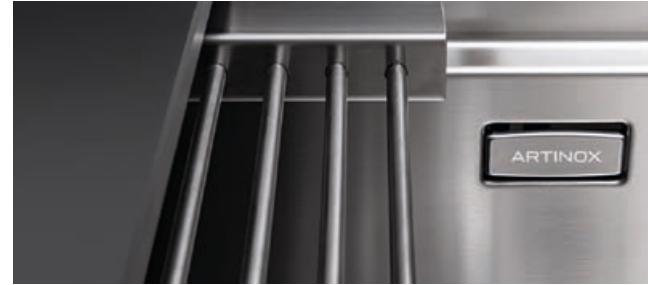

High thickness steel

We use AISI 304 stainless steel of increased thickness compared to normal market standards, guaranteeing robust products with a unique design.



Welded products

Artinox produces exclusively Kitchen systems with welding process, 10mm radius corner or zero/45 radius corners.

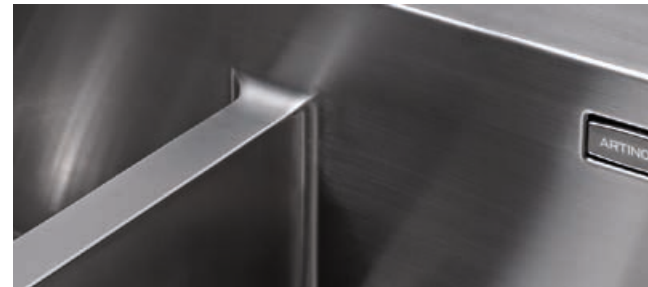

Generous sizes

Collections are available in various sizes from 170 to 250 depth.
Large capacity and functionality.

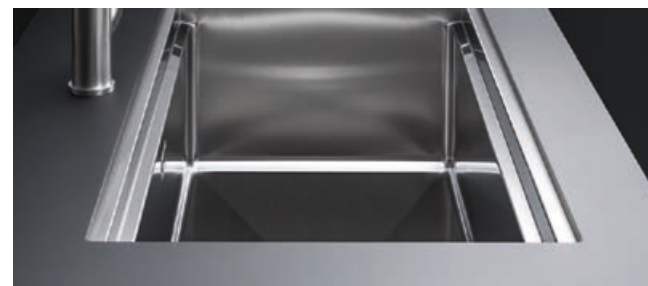

Holes

All the models in our collections are set up with one or two 35 mm diameter holes for housing the mixer. Additional holes can be requested.



Pop-up kit

The practical push pop-up kits, combined with the drains system, avoid getting your hands wet in emptying the sink. These are products from selected Italian partners.



Overflowing system

All products have an integrated back wall overflow and are designed without joints to ensure maximum hygiene.



Drainage enhanced bottoms

The outflow of the water is guaranteed also by an invitation near the drain and, in specific collections, also by elegant diamond-finished basin bottoms.



3 1/2" Drains

The exclusive drains of our models are produced by selected Italian partners. All models, variants and colors are always in stainless steel.



PaperStone®

PaperStone® is created from recycled paper and a proprietary resin. It is committed to innovative green products that contribute to an environmental sustainability.

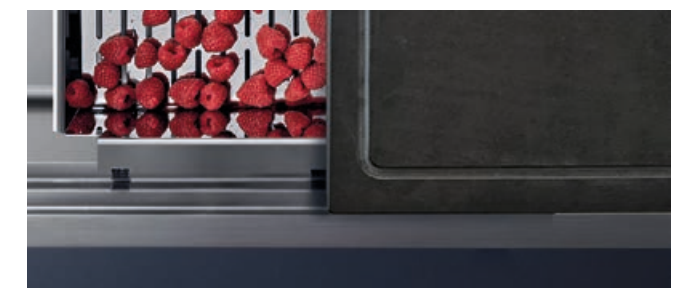

A SET-UP FOR EVERY STYLE

Over-mount

The over-mount option always allows easy installation on tops of any material.



Flush-mount

The visible perimeter of the Flush-mount evokes cleanliness, the edge is perfectly rectified with a two tenths of a millimeter tolerance.



Under-mount

The Under-mount solution allows you to make the most out of the surface of the kitchen countertop.

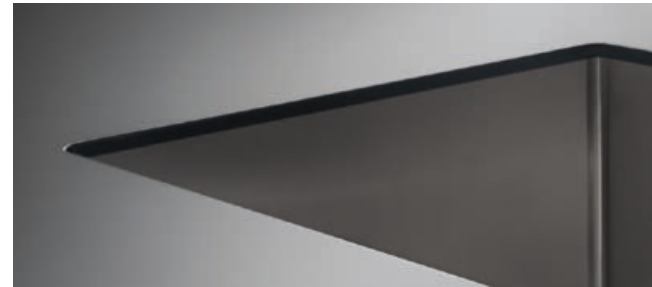

INDEX

OUTDOOR

STARTAC MARINA 16

GHOST MARINA 22

RADIUS MARINA 24

SINK MIXERS 32

CLEANING PRODUCTS 34

BUSINESS CONDITIONS 36



OUTDOOR

STARTAC MARINA

The kitchen expands into new outdoor spaces. Made of stainless steel AISI 316 L, Startac is designed to provide the same functionality and hygiene in the outdoor. Coming with a built-in cover, once closed, Startac discretely becomes one with the worktop.







STARTAC MARINA 55

READY



- Colander 58
- Circle Steel Tap 52

 Top mount Cod. **SAMC 55**

STARTAC MARINA 55

PRO



- Circle Steel Tap 52



 Top mount Cod. **SBMC 55**

STARTAC MARINA 55

SOLO



- Material AISI 316 L
- Finishing Brushed
- Inner corners R 10 mm welded
- Overall dimensions 590 x 510 mm
- Basin dimensions 550 x 350 mm
- Bowl depth 240 mm
- Plus Strainer 3 1/2"
- Cabinet size 600 mm

 Top mount Cod. **MC 55**
 Under mount Cod. **MC 55G**

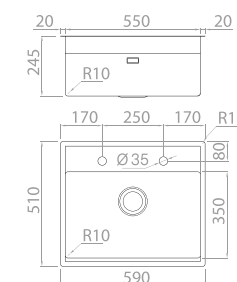

Accessories on page 30

GHOST MARINA

Made in premium quality AISI 316 L stainless steel, this brilliant solution is the ideal choice when space is limited. The lowering of the mixer docking area allows to conceal the mixer within the basins volume.



GHOST MARINA 60

READY

PaperStone® chopping board
Circle Steel Tap

73

52



Top mount
Under mount

Cod. **SAGO 60 MG**

Cod. **SAGS 60 MG**

GHOST MARINA 60

PRO

Circle Steel Tap

52



Top mount
Under mount

Cod. **SBGO 60 MG**

Cod. **SBGS 60 MG**

GHOST MARINA 60

SOLO

Material	AISI 316 L
Finishing	Brushed
Inner corners	R 10 mm welded
Overall dimensions	440 x 520 mm
Basin dimensions	400 x 400 + 80 mm
Bowl depth	65 / 200 mm
Plus Strainer	3 ½"
Cabinet size	600 mm



Top mount
Under mount

Cod. **SIG 60 MG**

Cod. **SSG 60 MG**

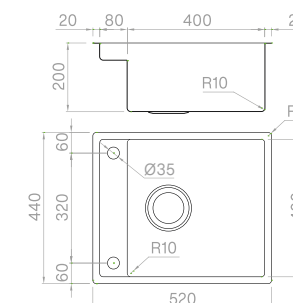

Accessories on page 30

RADIUS MARINA



This range is characterized by the chemical composition of AISI 316 L. This stainless-steel alloy is more resistant to corrosion and oxidation, making it a more suitable choice for the outdoor use, especially in saline environments.



RADIUS MARINA 70 READY





- PaperStone® chopping board **54**
- Slanted colander **51**
- Circle Steel Tap **52**

-  Top mount Cod. **SABI 70 MR**
-  Flush mount Cod. **SABG 70 MR**
-  Under mount Cod. **SABO 70 MR**

RADIUS MARINA 70 PRO





- Colander **50**

-  Top mount Cod. **SBBI 70 MR**
-  Flush mount Cod. **SBBG 70 MR**
-  Under mount Cod. **SBBO 70 MR**

RADIUS MARINA 70 SOLO



- Material AISI 316 L
- Finishing Brushed
- Inner corners R 10 mm welded
- Overall dimensions 740 x 530 mm
- Basin dimensions 700 x 400 mm
- Bowl depth 220 mm
- Standard Strainer 3 1/2"
- Cabinet size 800 mm

-  Top mount Cod. **BI 7040 MR**
-  Flush mount Cod. **BG 7040 MR**
-  Under mount Cod. **BO 7040 MR**

Accessories on page 30

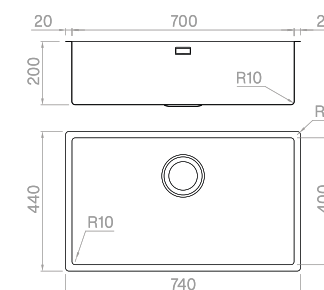

RADIUS MARINA 50

READY



- PaperStone® chopping board
- Slanted colander
- Circle Steel Tap

54
51
52

- Top mount
- Flush mount
- Under mount

Cod. **SABI 50 MR**
Cod. **SABG 50 MR**
Cod. **SABO 50 MR**

RADIUS MARINA 50

PRO



- Colander

50

- Top mount
- Flush mount
- Under mount

Cod. **SBBI 50 MR**
Cod. **SBBG 50 MR**
Cod. **SBBO 50 MR**

RADIUS MARINA 50

SOLO



- Material: AISI 316 L
- Finishing: Brushed
- Inner corners: R 10 mm welded
- Overall dimensions: 540 x 440 mm
- Basin dimensions: 500 x 400 mm
- Bowl depth: 200 mm
- Standard Strainer: 3 ½"
- Cabinet size: 600 mm

- Top mount
- Flush mount
- Under mount

Cod. **BI 5040 MR**
Cod. **BG 5040 MR**
Cod. **BO 5040 MR**

Accessories on page 30

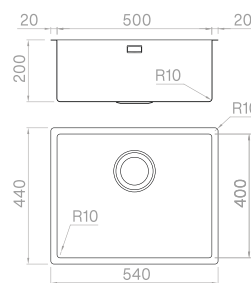

RADIUS MARINA 45

READY



- PaperStone® chopping board
- Colander
- Circle Steel Tap

54
50
52

- Top mount
- Flush mount
- Under mount

Cod. **SABI 45 MR**
Cod. **SABG 45 MR**
Cod. **SABO 45 MR**

RADIUS MARINA 45

PRO



- Colander

50

- Top mount
- Flush mount
- Under mount

Cod. **SBBI 45 MR**
Cod. **SBBG 45 MR**
Cod. **SBBO 45 MR**

RADIUS MARINA 45

SOLO



- Material: AISI 316 L
- Finishing: Brushed
- Inner corners: R 10 mm welded
- Overall dimensions: 490 x 440 mm
- Basin dimensions: 450 x 400 mm
- Bowl depth: 200 mm
- Standard Strainer: 3 ½"
- Cabinet size: 600 mm

- Top mount
- Flush mount
- Under mount

Cod. **BI 4540 MR**
Cod. **BG 4540 MR**
Cod. **BO 4540 MR**

Accessories on page 30

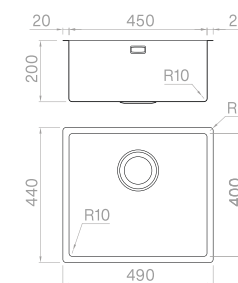

RADIUS MARINA 40

READY



- PaperStone® chopping board
- Colander
- Circle Steel Tap

54
50
52

- Top mount
- Flush mount
- Under mount

Cod. **SABI 40 MR**
Cod. **SABG 40 MR**
Cod. **SABO 40 MR**

RADIUS MARINA 40

PRO



- Colander

50

- Top mount
- Flush mount
- Under mount

Cod. **SBBI 40 MR**
Cod. **SBBG 40 MR**
Cod. **SBBO 40 MR**

RADIUS MARINA 40

SOLO



- Material: AISI 316 L
- Finishing: Brushed
- Inner corners: R 10 mm welded
- Overall dimensions: 440 x 440 mm
- Basin dimensions: 400 x 400 mm
- Bowl depth: 200 mm
- Standard Strainer: 3 ½"
- Cabinet size: 600 mm

- Top mount
- Flush mount
- Under mount

Cod. **BI 4040 MR**
Cod. **BG 4040 MR**
Cod. **BO 4040 MR**

Accessories on page 30

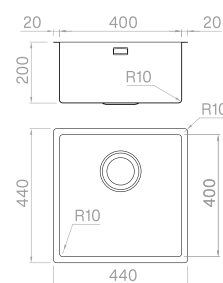

RADIUS MARINA 34

READY



- PaperStone® chopping board
- Colander
- Circle Steel Tap

54
50
52

- Top mount
- Flush mount
- Under mount

Cod. **SABI 34 MR**
Cod. **SABG 34 MR**
Cod. **SABO 34 MR**

RADIUS MARINA 34

PRO



- Colander

50

- Top mount
- Flush mount
- Under mount

Cod. **SBBI 34 MR**
Cod. **SBBG 34 MR**
Cod. **SBBO 34 MR**

RADIUS MARINA 34

SOLO



- Material: AISI 316 L
- Finishing: Brushed
- Inner corners: R 10 mm welded
- Overall dimensions: 380 x 440 mm
- Basin dimensions: 340 x 400 mm
- Bowl depth: 200 mm
- Standard Strainer: 3 ½"
- Cabinet size: 450 mm

- Top mount
- Flush mount
- Under mount

Cod. **BI 3440 MR**
Cod. **BG 3440 MR**
Cod. **BO 3440 MR**

Accessories on page 30

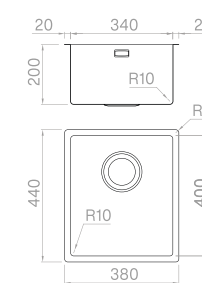

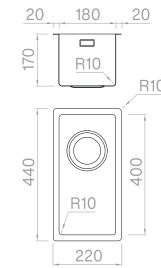

RADIUS MARINA 18

SOLO



Material	AISI 316 L
Finishing	Brushed
Inner corners	R 10 mm welded
Overall dimensions	220 x 440 mm
Basin dimensions	180 x 400 mm
Bowl depth	170 mm
Standard Strainer	3 1/2"
Cabinet size	300 mm

-  Top mount
-  Flush mount
-  Under mount

Cod. **BI 1840 MR**

Cod. **BG 1840 MR**

Cod. **BO 1840 MR**

DEDICATED ACCESSORIES

PaperStone® chopping board **54**

300x420x20 mm
Cod. **TRPS 3042**



PaperStone® chopping board **73**

200x420x19 mm
Cod. **TRPS 2042**



PaperStone® slicer/grater set **75**

200x420x20 mm
Cod. **TI 2442 GP**



Colander **50**

210x420x60 mm
Cod. **VQMF 2142**

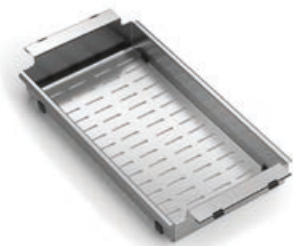

Slanted colander **51**

280x420x110/60 mm
Cod. **VQMI 2842**



Colander **58**

210x375x60 mm
Cod. **VQMF 2137**

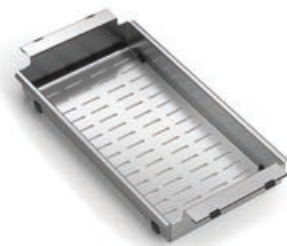

SINK MIXERS

CIRCLE STEEL



52

Material	Stainless steel AISI 316 L
Finishing	Brushed
Swivel angle	360°
Installation hole	Ø 35 mm
Cartridge	ceramic disc
Spray	extractable

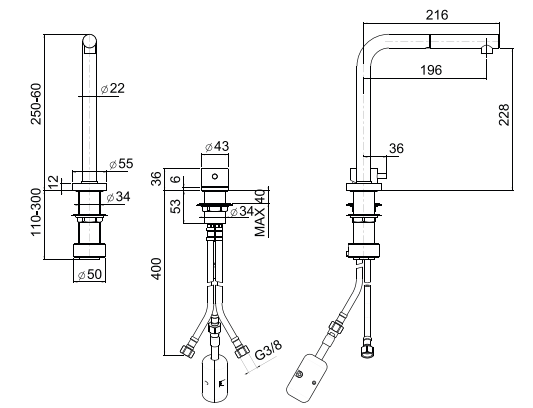

Cod. **SS 02802**

ARIAL STEEL



59

Material	Stainless steel AISI 316 L
Finishing	Brushed
Swivel angle	360°
Installation hole	Ø 35 mm
Cartridge	ceramic disc
Spray	extractable

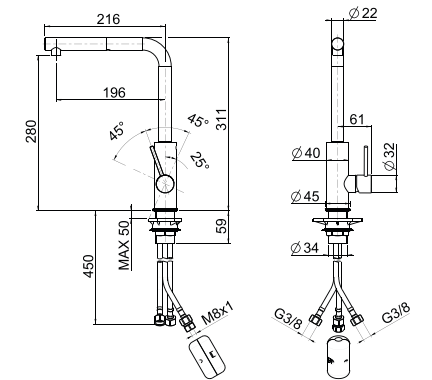

Cod. **SS 02820**

STAINLESS STEEL CARE



CLEANING - COMPLETE KIT

- Cleansing cream (250 ml bottle)
- Cleaning cloth
- Finishing cloth

Cod. **SS 01751**

Cod. **SS 02771** [12 Pks.]



CLEANSING CREAM

Specific for stainless steel.

Cod. **SS 02772** [12 Pcs.]



ANTIBACTERIAL CLOTH

Microfiber for finishing.
Size 40x40 cm - pack of 3
pieces.

Cod. **SS 02774** [12 Pks.]

ARTINOX workstation sinks are made of AISI 304 18/10 [EN 1.4301] stainless steel, a chromium-nickel steel alloy. Stainless steel is the hygienic material par excellence, tough and very resistant to corrosion, the ideal product for contact with food. All ARTINOX items are made in compliance with the strictest quality standards and tested one by one.

WARNINGS

Like all materials, stainless steel also requires regular care and daily cleaning. Improper use can damage the surface even permanently. The following recommendations protect the sink from corrosion damage caused by unsuitable cleaning agents.

CLEANING

For daily cleaning, we recommend squeezing a sponge out of hot water and dipping it in white vinegar. For deep cleaning, use ONLY official Artinox products, which can be purchased from authorized dealers or by consulting www.artinox.com.

MAINTENANCE

After each use, clean, rinse and dry the sink thoroughly with a soft cloth.

DO NOT leave detergents and cleaning products in contact with the surface for a long time.

DO NOT use hydrochloric acid, hydrofluoric acid, phosphoric acid, bleach, ammonia, or detergents that contain even small doses of these substances.

DO NOT use abrasive sponges, detergents and creams.

DO NOT leave objects, ferrous and non-ferrous metals inside the sink



GENERAL SELLING CONDITIONS

How to order:

We accept only written and complete orders. The order must indicate codes, as written in this price-list. Confirmation of order will follow, by fax and/or mail, and it is considered accepted if not contested within 3 days. The company Artinox spa reserves the right to change and/or cancel, if necessary, products, dimensions, descriptions and prices shown in this price list without notice and without any possibility for the customer to claim.

Delivery:

The delivery times are approximate and in reference to normal working conditions. In no case shall the seller be asked for reimbursement for any damages due to delayed delivery, nor shall the delay constitute a reason for cancellation of the contract. Quality and type of goods must be checked by the buyer at delivery.

Delivery terms:

Exw Conegliano (Treviso) Italy. Goods travel at the consignee's risk, even in case of free of charge delivery.

Packing:

Standard packing in cardboard boxes included in price. Special packing shall be charged at cost.

Prices:

The prices shown in this price list are exclusive of: vat, carriage, special packing, customs duties, wooden crates and/or pallets, assembly and final test and inspection.

Terms of payment:

To be agreed. All charges related to payment of bank commissions, stamp duties, etc. Shall be debited on the invoice. In the event of delayed payments, the company reserves the right to suspend delivery of the orders on hand, without obligation to give notice. The parties agree that the buyer will get the ownership of the material after payment of the total price, Accessories included, but he will take the risks after delivery of the goods [ex art. 1523 c.c. Italian law]. After the payment terms agreed by the two parties have fallen due, no complaint relating the quality of the goods can be made, unless regular payment of the goods has been effected.

Default interest:

Any delay in payments automatically leads to the charging of default interest at a rate of 1,5 % a month from the expiry date which is indicated in the invoice. Any charges borne to recover due amounts are for the buyer's account.

Warranty:

The warranty period is 24 months from the date of dispatch and covers every single part. The seller is not responsible for direct and/or indirect damages caused by and/or to equipments, plants, people for improper use, for bumps, wrong installation, for use out of tolerance.

Please give immediately notice of surface flaws such as blows, scratches, stains or breakages before installing or using any product. Any defect pointed out after the installation, as not attributable to fabrication flaws, will be excluded from the warranty.

Faulty parts are to be delivered ex our works (Conegliano Treviso - Italy) and will be replaced under guarantee only after through check. The recognized faulty parts will be replaced and mailed or sent free of charge by carrier. The guarantee does not cover the charges of replacement of parts, it is not transferable and complete replacement of parts or appliance is at the final discretion of the manufacturer.

Each product in this catalog is manufactured in compliance to current regulations and CE directives.

All data shown are not binding.

Artinox S.p.a. reserves the right to make changes deemed useful for the improvement of its offer at any time, without notice and disclaiming any responsibility for errors or inaccuracies.

The reproduction of the colors in the catalog are to be considered indicative.

Reproductions of all or part of this catalog are prohibited without the specific written authorization of Artinox S.p.a.

© Copyright 2024 Artinox S.p.a. - All rights reserved.

Ed. 5 - November 2024

ARTINOX

Artinox Spa

Via F. Fabbri, 39

z.i. Campidui

31015 Conegliano (TV)

+39 0438 4531

home@artinox.com

artinox-sinks.com

100 %
MADE IN
ITALY

