

ARTINOX

WORKSTATION SINKS

WORKSTATION SINKS

STORIA E PASSIONE

Artinox è stata fondata nel 1985 da Mario Zanardo a Conegliano, in una fra le più importanti aree industriali italiane specializzate nella lavorazione dell'acciaio.

Tutte le nostre collezioni, dedicate al mercato delle cucine di alta gamma, sono disegnate e prodotte con passione all'interno del nostro stabilimento per essere distribuite in tutto il mondo.



QUALITÀ E SOSTENIBILITÀ

Oltre alle qualità intrinseche della materia prima, siamo impegnati nell'implementazione del nostro sistema di gestione ambientale: in Artinox utilizziamo da sempre il controllo di tutti i processi per garantire il massimo risultato delle prestazioni offerte – certificazione ISO 9001 –, prendendoci cura dei fattori che interagiscono con l'ambiente – ISO 14001 –.



DESIGN FUNZIONALE

In Artinox rivoluzioniamo il tempo passato in cucina.
Tutte le workstation si integrano al piano di lavoro diventando un tutt'uno: il sistema sliding permette il posizionamento e lo scorrimento di infiniti accessori dedicati a molteplici funzionalità, dalle griglie ai supporti, dai taglieri ai contenitori fatti per durare e per servire con un semplice gesto.



IL NOSTRO ACCIAIO INOX

Il nostro acciaio inossidabile AISI 304 e AISI 316 è utilizzato in ambienti sia domestici che professionali, conforme a tutti gli standard di settore. È estremamente facile da pulire grazie alla superficie priva di pori, che comporta un'alta proprietà antibatterica. Il nostro acciaio è inalterabile nel tempo, è composto per oltre il 70% da materiali riciclati ed è riciclabile al 100%.

Artinox ha scelto l'AISI 316 L per la collezione OUTDOOR, una linea completa di prodotti adatti all'outdoor. Questo acciaio inossidabile è un materiale speciale, tipicamente utilizzato nel settore nautico e ambienti chirurgici. Offre un'elevatissima resistenza alla salsedine così come agli acidi degli alimenti.





DETTAGLI CHE FANNO LA DIFFERENZA

Accessori dedicati

Gli accessori in acciaio inox, sempre prodotti in alto spessore nei nostri stabilimenti, sono lavabili in lavastoviglie. I taglieri sono in legno o in polietilene atossico.

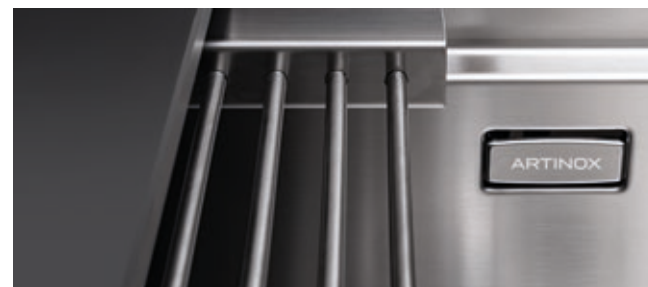

Acciaio di alto spessore

Utilizziamo acciaio inossidabile AISI 304 di spessore maggiorato rispetto ai normali standard di mercato, garantendo prodotti robusti dal design unico.



Prodotti saldati

In Artinox produciamo sistemi di lavaggio con angoli interni saldati a raggio 10 mm o zero/45. Design unico e contemporaneo.

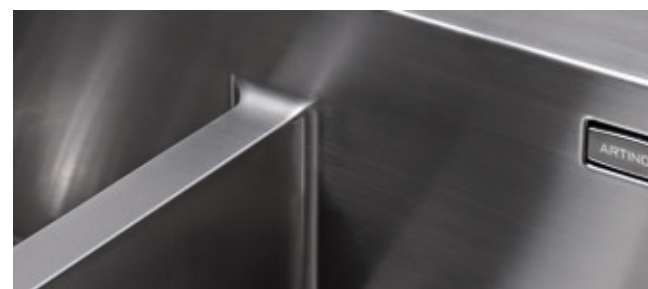

Dimensioni capienti

Le collezioni sono disponibili in molteplici dimensioni e con profondità da 170 a 250 mm. Garanzia, grande capienza e praticità operativa.



Fori miscelatori

Tutti i modelli delle nostre collezioni sono predisposti con uno o due fori diametro 35 mm per l'alloggio del miscelatore. È possibile richiedere fori aggiuntivi.



Kit saltarello

I pratici kit saltarello push evitano di bagnarsi le mani e sono in abbinamento alle finiture Artinox. Prodotti da selezionati partner italiani.



Trooppieno

Il trooppieno è integrato sulla parete posteriore, senza giunture per garantire la massima igiene.



Fondi inclinati

Il deflusso dell'acqua è sempre garantito da un invito in prossimità della piletta.



Pilette 3 1/2"

Le esclusive pilette dei nostri modelli sono prodotti da selezionati partner italiani. Tutti i modelli, le varianti e le colorazioni sono sempre in acciaio inox.



PaperStone®

PaperStone® è il materiale ecosostenibile per il design. Creato da carta riciclata e una resina brevettata si distingue come materiale sostenibile, riutilizzabile, riciclabile e non tossico.



UN ALLESTIMENTO PER OGNI STILE

Sopratop

Il sopratop permette sempre la facile installazione su piani di qualsiasi materiale.



Filotop

L'elegante perimetro a vista filotop ha il bordo rettificato con una tolleranza di due decimi.



Sottotop

La soluzione sottotop permette di sfruttare al massimo la superficie del piano di lavoro.



Edgeless

Con Edgeless le giunzioni con il piano di lavoro spariscono. Massima igiene ed estetica.



Fondo Integrato

L'innovativa installazione con fondo in inox e pareti in continuità con il piano di lavoro.

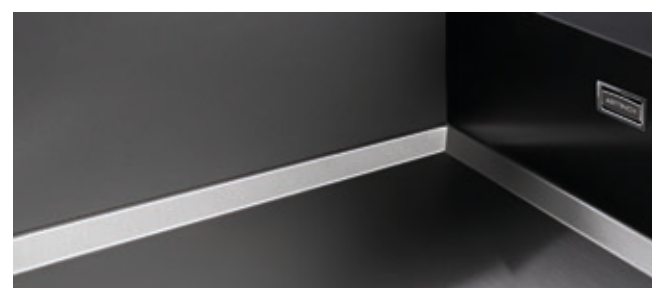

INDICE

WORKSTATIONS

PLANUM	22
LAYER	44

INTEGRATI

LINEA	74
SHORE	84

SINKS

TITANIUM	96
RADIUS	110
PRISMA	128
GHOST	140
MOSE	144
NEWGO	152
AQUA	162

OUTDOOR

STARTAC MARINA	172
GHOST MARINA	178
RADIUS MARINA	180

CANALI ATTREZZATI

MISCELATORI	204
COMPLEMENTI	210
PRODOTTI PER LA PULIZIA	212
CONDIZIONI DI VENDITA	214

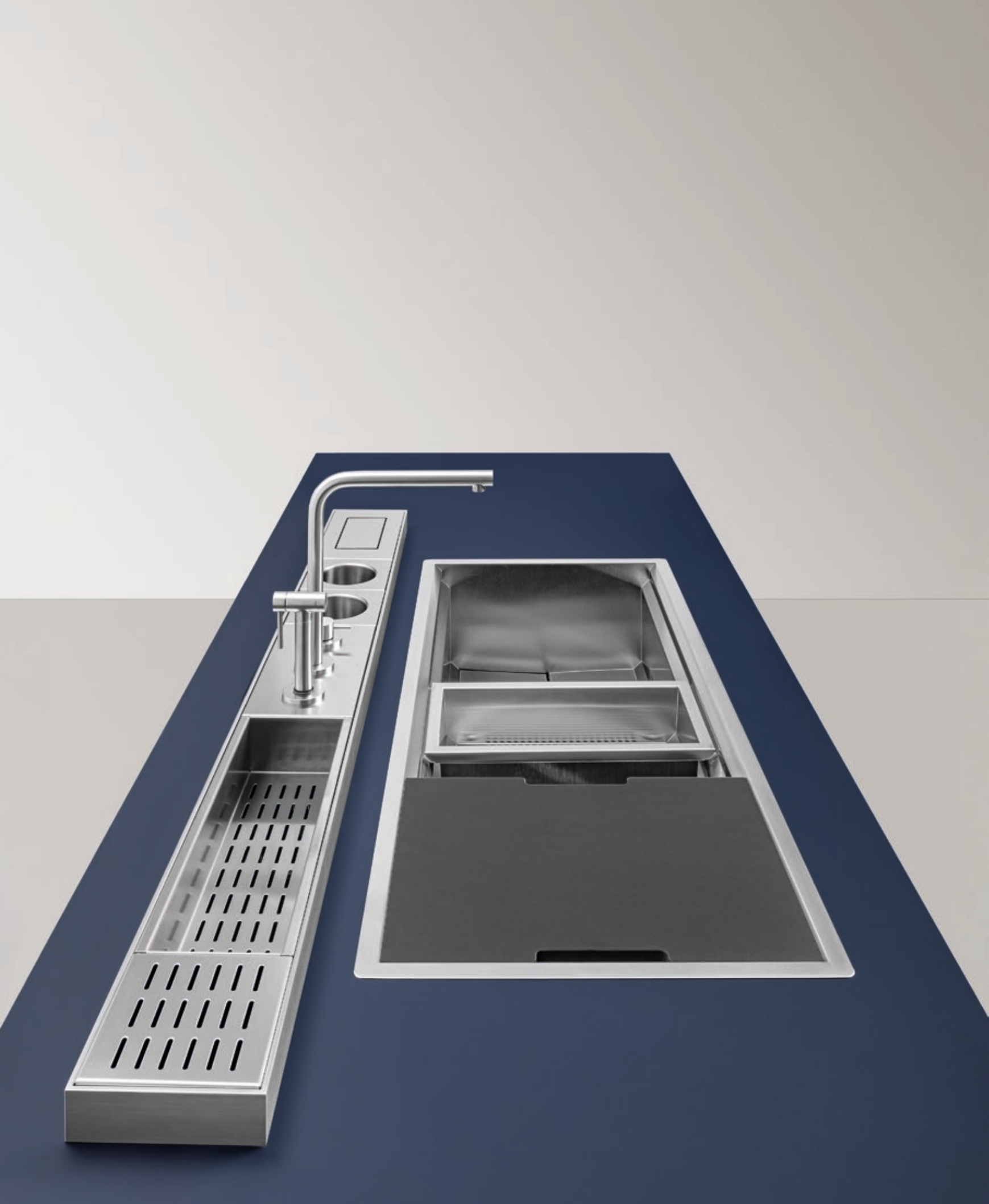

WORKSTATIONS

PLANUM



PLANUM XL

La collezione Planum è caratterizzata da grandi dimensioni e dal doppio sistema sliding dove è possibile far scorrere e abbinare numerosi accessori. Queste caratteristiche permettono di estendere la funzionalità del piano di lavoro valorizzando al meglio l'esperienza in cucina.

PLANUM XL 111

READY



Tagliere in legno
Vaschetta inclinata forata
Vaschetta
Griglia
Miscelatore Loft
Miscelatore Loft

1
23
26
10
38
38

 Sopratop

Cod. **SAP I 11**

PLANUM XL 111

PRO



Tagliere in legno
Vaschetta inclinata forata

1
23

 Sopratop

Cod. **SBP I 11**

PLANUM XL 111

SOLO



Materiale	AISI 304
Finitura	Spazzolato
Raggio interno	Saldato 10 mm
Misure esterne	1160 x 510 mm
Misure vasca	1110 x 400 mm
Profondità vasca	254 mm
Piletta Plus	3 1/2"
Base	1200 mm

 Sopratop

Cod. **PI 11 4025**

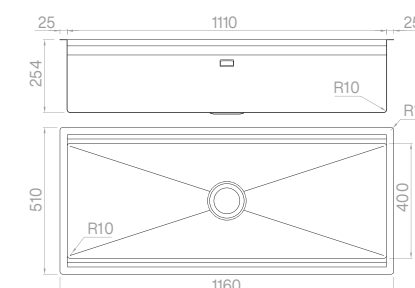

Accessori a pag. 32

PLANUM XL 81 **READY**



- Tagliere in legno
- Vaschetta inclinata forata
- Griglia
- Miscelatore Loft

1
23
10
38



Cod. **SAP I 81**

PLANUM XL 81 **PRO**



- Tagliere in legno
- Vaschetta inclinata forata

1
23



Cod. **SBP I 81**

PLANUM XL 81 **SOLO**



- | | |
|------------------|---------------|
| Materiale | AISI 304 |
| Finitura | Spazzolato |
| Raggio interno | Saldato 10 mm |
| Misure esterne | 860 x 510 mm |
| Misure vasca | 810 x 400 mm |
| Profondità vasca | 254 mm |
| Piletta Plus | 3 ½" |
| Base | 900 mm |



Cod. **PI 81 4025**

Accessori a pag. 32

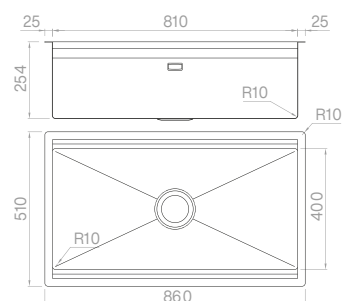

PLANUM XL 70 **READY**



- Tagliere in legno
- Vaschetta inclinata forata
- Griglia
- Miscelatore Loft

1
23
10
38



Cod. **SAP I 70**

PLANUM XL 70 **PRO**



- Tagliere in legno
- Vaschetta inclinata forata

1
23



Cod. **SBP I 70**

PLANUM XL 70 **SOLO**



- | | |
|------------------|---------------|
| Materiale | AISI 304 |
| Finitura | Spazzolato |
| Raggio interno | Saldato 10 mm |
| Misure esterne | 750 x 510 mm |
| Misure vasca | 700 x 400 mm |
| Profondità vasca | 254 mm |
| Piletta Plus | 3 ½" |
| Base | 800 mm |



Cod. **PI 70 4025**

Accessori a pag. 32

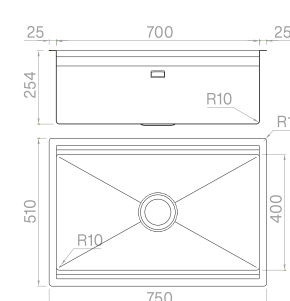

PLANUM XT

In questa funzionale workstation gli accessori alloggiati su due livelli distinti. Sul livello superiore scorrono innovative superfici di appoggio realizzate in nobili materiali, mentre il livello inferiore accoglie i contenitori per scolare e contenere gli alimenti di preparazione.



PLANUM XT 111

READY



Tagliere in legno
 Vaschetta inclinata forata
 Vaschetta
 Griglia
 Miselatore Loft

1
 23
 26
 10
 38

Sottotop

Cod. **SAP0 11 XT**

PLANUM XT 111

PRO



Tagliere in legno
 Vaschetta inclinata forata

1
 23

Sottotop

Cod. **SBPO 11 XT**

PLANUM XT 111

SOLO



Materiale	AISI 304
Finitura	Spazzolato
Raggio interno	Saldato 10 mm
Misure esterne	1150 x 490 mm
Misure vasca	1110 x 400 mm
Profondità vasca	234 mm
Piletta Plus	3 1/2"
Base	1200 mm

Sottotop

Cod. **PO 11 XT**

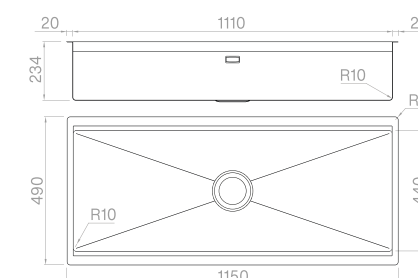

Accessori a pag. 32

PLANUM XT 81

READY



- Tagliere in legno
- Vaschetta inclinata forata
- Griglia
- Miscelatore Loft

- 1
- 23
- 10
- 38

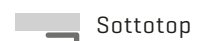

Sottotop

Cod. **SAP0 81 XT**

PLANUM XT 81

PRO



- Tagliere in legno
- Vaschetta inclinata forata

- 1
- 23



Sottotop

Cod. **SBP0 81 XT**

PLANUM XT 81

SOLO



- | | |
|------------------|---------------|
| Materiale | AISI 304 |
| Finitura | Spazzolato |
| Raggio interno | Saldato 10 mm |
| Misure esterne | 850 x 490 mm |
| Misure vasca | 810 x 400 mm |
| Profondità vasca | 234 mm |
| Piletta Plus | 3 ½" |
| Base | 900 mm |



Sottotop

Cod. **PO 81 XT**

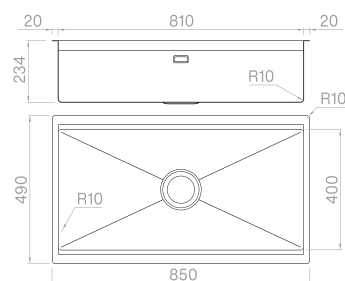

Accessori a pag. 32



Livello superiore

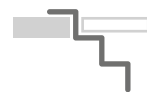

Tagliere in legno rovere

1

300x457x20 mm
Cod. **TRIB 3045**



Tagliere in PaperStone®

55

300x460x20 mm
Cod. **TRPS 3045**



Griglia

10

300x457x25 mm
Cod. **GRS 3045**



Livello inferiore

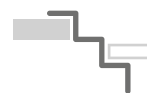

Tagliere in HDPE

6

240x420x20 mm
Cod. **TRP 2442**



Vaschetta forata

16

210x420x60 mm
Cod. **VQSF 2142**



Set scolapasta PaperStone®

77

200x420x20 mm
Cod. **TI 2442 SP**



Set grattugie PaperStone®

75

200x420x20 mm
Cod. **TI 2442 GP**



Set porta bottiglie rovere

7

130x457x170 mm
Cod. **VPB 3C**



PaperStone® Set porta bottiglie

72

130x457x170 mm
Cod. **VPB 3CPA**



Gocciolatoio

8

250x457x15 mm
Cod. **VPB 2545**

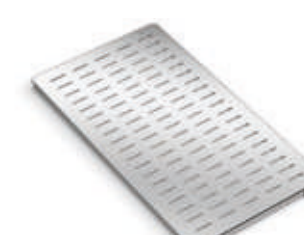

Vaschetta inclinata forata

23

280x420x110/60 mm
Cod. **VQSI 2842**



Vaschetta

26

280x420x160 mm
Cod. **VQSP 2842**



Set gastronorm PaperStone®

76

200x420x20 mm
Cod. **TI 2442 VP**



Porta piatti

36

250x420x55 mm
Cod. **PPPB V400**



Gocciolatoio

61

340x420x30 mm
Cod. **VQSI 3442**



PLANUM ST

La funzionalità della collezione Planum in uno spazio più contenuto. L'installazione sottotop permette di sfruttare al massimo la superficie del piano di lavoro.



PLANUM ST 111

READY



- Tagliere in legno
- Vaschetta inclinata forata
- Vaschetta
- Griglia
- Miscelatore Loft

- 2
- 25
- 27
- 11
- 38

 Sottotop

Cod. **SAP0 11 L1**

PLANUM ST 111

PRO



- Tagliere in legno
- Vaschetta inclinata forata

- 2
- 25

 Sottotop

Cod. **SBPO 11 L1**

PLANUM ST 111

SOLO



Materiale	AISI 304
Finitura	Spazzolato
Raggio interno	Saldato 10 mm
Misure esterne	1150 x 440 mm
Misure vasca	1110 x 350 mm
Profondità vasca	234 mm
Piletta Plus	3 1/2"
Base	1200 mm

 Sottotop

Cod. **PO 11 L1**

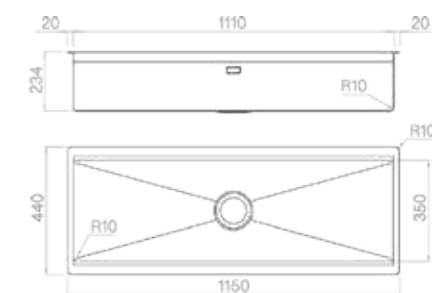

Accessori a pag. 43

PLANUM ST 81 **READY**



- Tagliere in legno **2**
- Vaschetta inclinata forata **25**
- Griglia **11**
- Miscelatore Loft **38**

Sottotop Cod. **SAP0 81 L1**

PLANUM ST 70 **READY**

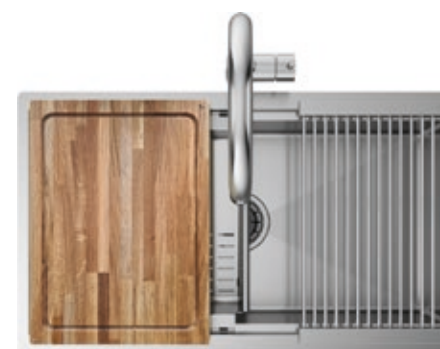

- Tagliere in legno **2**
- Vaschetta inclinata forata **25**
- Griglia **11**
- Miscelatore Loft **38**

Sottotop Cod. **SAP0 70 L1**

PLANUM ST 81 **PRO**



- Tagliere in legno **2**
- Vaschetta inclinata forata **25**

Sottotop Cod. **SBPO 81 L1**

PLANUM ST 70 **PRO**



- Tagliere in legno **2**
- Vaschetta inclinata forata **25**

Sottotop Cod. **SBPO 70 L1**

PLANUM ST 81 **SOLO**



- | | |
|------------------|---------------|
| Materiale | AISI 304 |
| Finitura | Spazzolato |
| Raggio interno | Saldato 10 mm |
| Misure esterne | 850 x 440 mm |
| Misure vasca | 810 x 350 mm |
| Profondità vasca | 234 mm |
| Piletta Plus | 3 ½" |
| Base | 900 mm |

Sottotop Cod. **PO 81 L1**

PLANUM ST 70 **SOLO**



- | | |
|------------------|---------------|
| Materiale | AISI 304 |
| Finitura | Spazzolato |
| Raggio interno | Saldato 10 mm |
| Misure esterne | 740 x 440 mm |
| Misure vasca | 700 x 350 mm |
| Profondità vasca | 234 mm |
| Piletta Plus | 3 ½" |
| Base | 800 mm |

Sottotop Cod. **PO 70 L1**

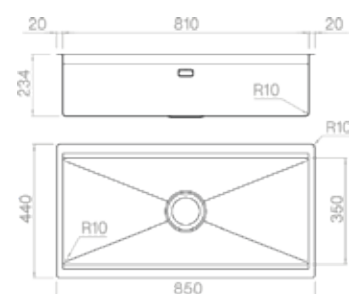

Accessori a pag. 43

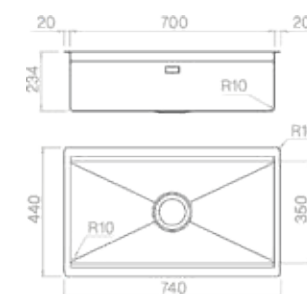

Accessori a pag. 43

PLANUM BR

Tutte le workstation Planum si caratterizzano per il doppio livello di scorrimento. Molteplici combinazioni fra accessori garantiscono la massima personalizzazione dell'area operativa.



PLANUM BR 111

READY



- Tagliere in legno
- Vaschetta inclinata forata
- Vaschetta
- Griglia
- Miscelatore Loft

- 2
- 25
- 27
- 11
- 38

 Sopratop

Cod. **SAP BRI 11**

PLANUM BR 111

PRO



- Tagliere in legno
- Vaschetta inclinata forata

- 2
- 25

 Sopratop

Cod. **SBP BRI 11**

PLANUM BR 111

SOLO



- | | |
|------------------|---------------|
| Materiale | AISI 304 |
| Finitura | Spazzolato |
| Raggio interno | Saldato 10 mm |
| Misure esterne | 1160 x 505 mm |
| Misure vasca | 1110 x 350 mm |
| Profondità vasca | 254 mm |
| Piletta Plus | 3 1/2" |
| Base | 1200 mm |

 Sopratop

Cod. **ALP BRI 11**

Foro miscelatore:
specificare fori
extra in fase di
ordine.

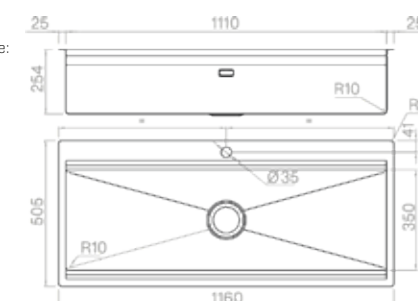

Accessori a pag. 43

PLANUM BR 81 **READY**



- Tagliere in legno **2**
- Vaschetta inclinata forata **25**
- Griglia **11**
- Miscelatore Loft **38**

 Sopratop Cod. **SAP BRI 81**

PLANUM BR 70 **READY**



- Tagliere in legno **2**
- Vaschetta inclinata forata **25**
- Griglia **11**
- Miscelatore Loft **38**

 Sopratop Cod. **SAP BRI 70**

PLANUM BR 81 **PRO**



- Tagliere in legno **2**
- Vaschetta inclinata forata **25**

 Sopratop Cod. **SBP BRI 81**

PLANUM BR 70 **PRO**



- Tagliere in legno **2**
- Vaschetta inclinata forata **25**

 Sopratop Cod. **SBP BRI 70**

PLANUM BR 81 **SOLO**



- | | |
|------------------|---------------|
| Materiale | AISI 304 |
| Finitura | Spazzolato |
| Raggio interno | Saldato 10 mm |
| Misure esterne | 860 x 505 mm |
| Misure vasca | 810 x 350 mm |
| Profondità vasca | 254 mm |
| Piletta Plus | 3 ½" |
| Base | 900 mm |

 Sopratop Cod. **ALP BRI 81**

PLANUM BR 70 **SOLO**



- | | |
|------------------|---------------|
| Materiale | AISI 304 |
| Finitura | Spazzolato |
| Raggio interno | Saldato 10 mm |
| Misure esterne | 750 x 505 mm |
| Misure vasca | 700 x 350 mm |
| Profondità vasca | 254 mm |
| Piletta Plus | 3 ½" |
| Base | 800 mm |

 Sopratop Cod. **ALP BRI 70**

Foro miscelatore:
specificare fori extra
in fase di ordine.

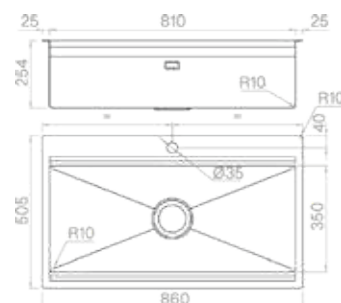

Accessori a pag. 43

Foro miscelatore:
specificare fori extra
in fase di ordine.

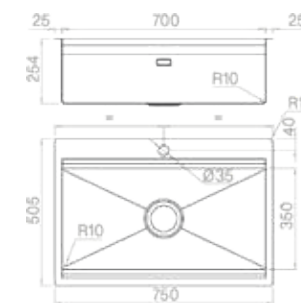

Accessori a pag. 43



Livello superiore



Tagliere in legno rovere

2

300x407x20 mm
Cod. **TRIB 3041**



Tagliere in PaperStone®

53

300x407x20 mm
Cod. **TRPS 3041**



Gocciolatoio

9

250x407x15 mm
Cod. **VPB 2541**



Griglia

11

300x407x25 mm
Cod. **GRS 3041**



Set tagliere + gastronorm

31

300x405x100 mm
Cod. **TPLB 3V**



Set tagliere + colapasta

33

300x405x100 mm
Cod. **TPLB 1S**



Set tagliere + telaio porta coltelli

35

300x405x20 mm
Cod. **TPLB 4030**



Livello inferiore



Vaschetta forata

20

210x375x60 mm
Cod. **VQSF 2137**



Vaschetta inclinata forata

25

280x370x110/60 mm
Cod. **VQSI 2837**



Vaschetta

27

280x370x160 mm
Cod. **VQSP 2837**



LAYER



LAYER BRL

Un'estetica essenziale e funzionale grazie all'ampia profondità che aumenta la capienza. Tutto è contenuto all'interno dello spazio in cui ogni accessorio scorre perfettamente allineato al piano di lavoro.



LAYER BRL 104 **READY**



- Tagliere in legno
- Vaschetta forata
- Griglia
- Miscelatore Element

4
48
14
40



Cod. **SA BRL I 10**
Cod. **SA BRLO 10**

LAYER BRL 104 **PRO**



- Tagliere in legno
- Vaschetta forata

4
48



Cod. **SB BRL I 10**
Cod. **SB BRLO 10**

LAYER BRL 104 **SOLO**



- | | |
|------------------|---------------|
| Materiale | AISI 304 |
| Finitura | Spazzolato |
| Raggio interno | Raggio '0' |
| Misure esterne | 1080 x 510 mm |
| Misure vasca | 960 x 410 mm |
| Profondità vasca | 230 mm |
| Piletta Plus | 3 ½" |
| Base | 1200 mm |



Cod. **AL BRL I 10**
Cod. **AL BRLO 10**

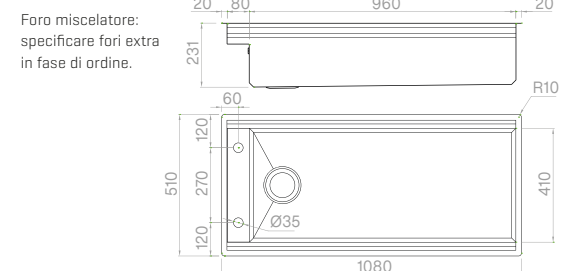

Accessori a pag. 51

LAYER BRL 74 **READY**



- Tagliere in legno
- Vaschetta forata
- Miscelatore Element

4
48
40



Cod. **SA BRL I 74**
Cod. **SA BRLO 74**

LAYER BRL 74 **PRO**



- Tagliere in legno

4



Cod. **SB BRL I 74**
Cod. **SB BRLO 74**

LAYER BRL 74 **SOLO**



- | | |
|------------------|--------------|
| Materiale | AISI 304 |
| Finitura | Spazzolato |
| Raggio interno | Raggio '0' |
| Misure esterne | 780 x 510 mm |
| Misure vasca | 660 x 410 mm |
| Profondità vasca | 230 mm |
| Piletta Plus | 3 ½" |
| Base | 900 mm |



Cod. **AL BRL I 74**
Cod. **AL BRLO 74**

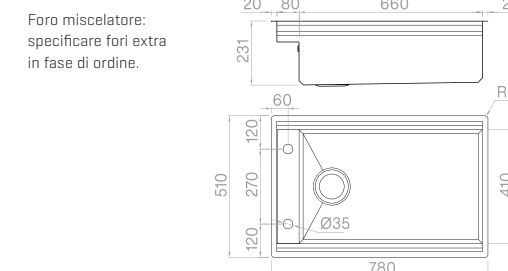

Accessori a pag. 51

LAYER BRL 50 **READY**



Tagliere in legno
Vaschetta forata
Miscelatore Circle

4
21
45

Sopratop
Sottotop

Cod. **SA BRL I 50**
Cod. **SA BRLO 50**

LAYER BRL 50 **PRO**



Miscelatore Circle

45

Sopratop
Sottotop

Cod. **SB BRL I 50**
Cod. **SB BRLO 50**

LAYER BRL 50 **SOLO**



Materiale	AISI 304
Finitura	Spazzolato
Raggio interno	Raggio '0'
Misure esterne	540 x 510 mm
Misure vasca	420 x 410 mm
Profondità vasca	230 mm
Piletta Plus	3 1/2"
Base	600 mm

Sopratop
Sottotop

Cod. **AL BRL I 50**
Cod. **AL BRLO 50**

Foro miscelatore:
specificare fori extra
in fase di ordine.

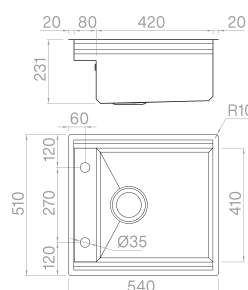

Accessori a pag. 51

Livello superiore



Tagliere in legno acacia

345x465x25 mm
Cod. **TBRL 4634**



4

Griglia

300x465x25 mm
Cod. **GFL 4630**



14

Tagliere in PaperStone®

345x465x20 mm
Cod. **TPBR 4634**



Livello inferiore

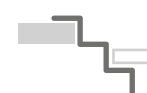

Vaschetta forata

190x435x80 mm
Cod. **VFPB RL19**



21

Vaschetta

345x435x160 mm
Cod. **VGB RL34**



28

Vaschetta forata

345x435x80 mm
Cod. **VFGB RL34**



48

LAYER SBR SP



LAYER SBR SP 81

READY



- Tagliere in legno
- Vaschetta forata
- Griglia
- Miscelatore Hero

5
49
15
39

- Sopratop
- Sottotop

Cod. **SASB 81 SP**

Cod. **SASB 81 PS**

LAYER SBR SP 81

PRO



- Tagliere in legno
- Vaschetta forata

5
49

- Sopratop
- Sottotop

Cod. **SBSB 81 SP**

Cod. **SBSB 81 PS**

LAYER SBR SP 81

SOLO



- | | |
|------------------|--------------|
| Materiale | AISI 304 |
| Finitura | Spazzolato |
| Raggio interno | Raggio '0' |
| Misure esterne | 850 x 450 mm |
| Misure vasca | 810 x 350 mm |
| Profondità vasca | 240 mm |
| Piletta standard | 3 1/2" |
| Base | 900 mm |

- Sopratop
- Sottotop

Cod. **ALSB 81 SP**

Cod. **ALSB 81 PS**

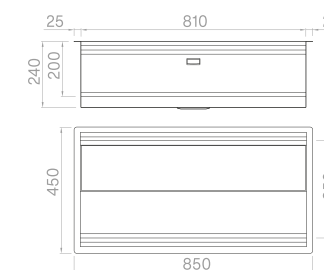

Accessori a pag. 71

LAYER SBR

Una workstation icona grazie a taglieri, vassoi e tanti speciali accessori scorrevoli che permettono un'area di lavoro funzionale e personalizzabile in infinite possibilità.



LAYER SBR 104

READY



Tagliere in legno
Vaschetta forata
Griglia
Miscelatore Element

5
49
15
40

— Sopratop
— Sottotop

Cod. **SA SBR 104**
Cod. **SA SBR ST1**

LAYER SBR 104

PRO



Tagliere in legno
Vaschetta forata

5
49

— Sopratop
— Sottotop

Cod. **SB SBR 104**
Cod. **SB SBR ST1**

LAYER SBR 104

SOLO



Materiale	AISI 304
Finitura	Spazzolato
Raggio interno	Raggio '0'
Misure esterne	1080 x 450 mm
Misure vasca	1040 x 350 mm
Profondità vasca	210 mm
Piletta Plus	3 1/2"
Base	1200 mm

— Sopratop
— Sottotop

Cod. **SBR 104**
Cod. **SBR ST 104**

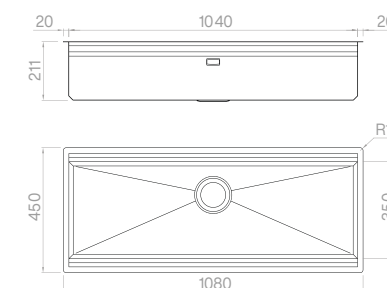

Accessori a pag. 71

LAYER SBR 81 READY



- Tagliere in legno
- Vaschetta forata
- Griglia
- Miscelatore Vertigo

- 5
- 49
- 15
- 47



Cod. **SA SBR 81**
Cod. **SA SBR ST8**

LAYER SBR 81 PRO



- Tagliere in legno
- Vaschetta forata

- 5
- 49



Cod. **SB SBR 81**
Cod. **SB SBR ST8**

LAYER SBR 81 SOLO



- | | |
|------------------|--------------|
| Materiale | AISI 304 |
| Finitura | Spazzolato |
| Raggio interno | Raggio '0' |
| Misure esterne | 850 x 450 mm |
| Misure vasca | 810 x 350 mm |
| Profondità vasca | 210 mm |
| Piletta Plus | 3 1/2" |
| Base | 900 mm |



Cod. **SBR 81**
Cod. **SBR ST 81**

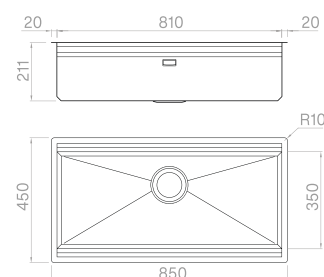

Accessori a pag. 71

LAYER SBR 70 READY



- Tagliere in legno
- Vaschetta forata
- Griglia
- Miscelatore Vertigo

- 5
- 22
- 15
- 47



Cod. **SA SBR 70**
Cod. **SA SBR ST7**

LAYER SBR 70 PRO



- Tagliere in legno
- Vaschetta forata

- 5
- 22



Cod. **SB SBR 70**
Cod. **SB SBR ST7**

LAYER SBR 70 SOLO



- | | |
|------------------|--------------|
| Materiale | AISI 304 |
| Finitura | Spazzolato |
| Raggio interno | Raggio '0' |
| Misure esterne | 740 x 450 mm |
| Misure vasca | 700 x 350 mm |
| Profondità vasca | 210 mm |
| Piletta Plus | 3 1/2" |
| Base | 800 mm |



Cod. **SBR 70**
Cod. **SBR ST 70**

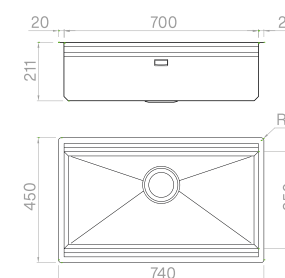

Accessori a pag. 71

LAYER SBR 65 READY



Tagliere in legno
Vaschetta forata
Miscelatore Vertigo

5
22
47



Cod. **SA SBR 65**
Cod. **SA SBR ST6**

LAYER SBR 65 PRO



Tagliere in legno

5



Cod. **SB SBR 65**
Cod. **SB SBR ST6**

LAYER SBR 65 SOLO



Materiale	AISI 304
Finitura	Spazzolato
Raggio interno	Raggio '0'
Misure esterne	690 x 450 mm
Misure vasca	650 x 350 mm
Profondità vasca	210 mm
Piletta Plus	3 1/2"
Base	750 mm



Cod. **SBR 65**
Cod. **SBR ST 65**

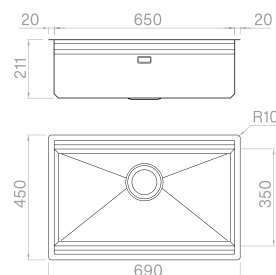

Accessori a pag. 71

LAYER SBR 50 READY



Tagliere in legno
Vaschetta forata
Miscelatore Vertigo

5
22
47



Cod. **SA SBR 50**
Cod. **SA SBR ST5**

LAYER SBR 50 PRO



Tagliere in legno

5



Cod. **SB SBR 50**
Cod. **SB SBR ST5**

LAYER SBR 50 SOLO



Materiale	AISI 304
Finitura	Spazzolato
Raggio interno	Raggio '0'
Misure esterne	540 x 450 mm
Misure vasca	500 x 350 mm
Profondità vasca	210 mm
Piletta Plus	3 1/2"
Base	600 mm



Cod. **SBR 50**
Cod. **SBR ST 50**

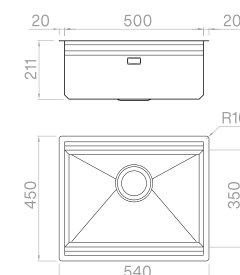

Accessori a pag. 71

LAYER SP



Il design esclusivo di Layer SP è definito da linee pure caratterizzate da un funzionale sportello sul fondo che cela lo scarico al suo interno.

LAYER SP 81 READY



- Tagliere in legno
- Vaschetta forata
- Griglia
- Miscelatore Hero

- 5
- 49
- 15
- 39



Cod. **SA BR81 SP**

LAYER SP 70 READY



- Tagliere in legno
- Vaschetta forata
- Griglia
- Miscelatore Hero

- 5
- 22
- 15
- 39



Cod. **SA BR70 SP**

LAYER SP 81 PRO



- Tagliere in legno
- Vaschetta forata

- 5
- 49



Cod. **SB BR81 SP**

LAYER SP 70 PRO



- Tagliere in legno
- Vaschetta forata

- 5
- 22



Cod. **SB BR70 SP**

LAYER SP 81 SOLO



Materiale	AISI 304
Finitura	Spazzolato
Raggio interno	Raggio '0'
Misure esterne	860 x 510 mm
Misure vasca	810 x 350 mm
Profondità vasca	240 mm
Piletta automatica	3 ½"
Base	900 mm



Cod. **AL BR81 SP**

LAYER SP 70 SOLO



Materiale	AISI 304
Finitura	Spazzolato
Raggio interno	Raggio '0'
Misure esterne	740 x 510 mm
Misure vasca	700 x 350 mm
Profondità vasca	240 mm
Piletta automatica	3 ½"
Base	800 mm



Cod. **AL BR70 SP**

Foro miscelatore:
specificare fori extra
in fase di ordine.

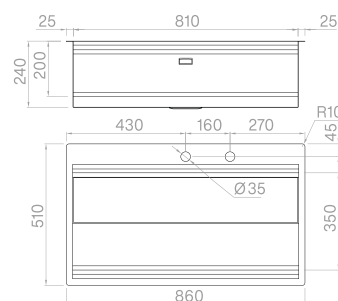

Accessori a pag. 71

Foro miscelatore:
specificare fori extra
in fase di ordine.

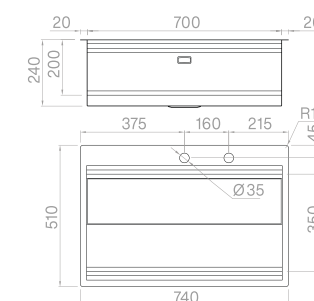

Accessori a pag. 71

LAYER BRP

Un design inclinato esclusivo, dove accessori dedicati scorrono su due livelli. Il livello superiore, dedicato a griglie e taglieri, è accompagnato da un livello sottostante, dove vaschette e contenitori esprimono la massima funzionalità.



LAYER BRP 104

READY



- Tagliere in legno
- Vaschetta forata
- Griglia
- Miscelatore Element

5
49
15
40

 Sopratop

Cod. **SA BRP 104**

LAYER BRP 104

PRO



- Tagliere in legno
- Vaschetta forata

5
49

 Sopratop

Cod. **SB BRP 104**

LAYER BRP 104

SOLO



Materiale	AISI 304
Finitura	Spazzolato
Raggio interno	Raggio '0'
Misure esterne	1080 x 510 mm
Misure vasca	1040 x 350 mm
Profondità vasca	210 mm
Piletta Plus	3 1/2"
Base	1200 mm

 Sopratop

Cod. **AL BRP 104**

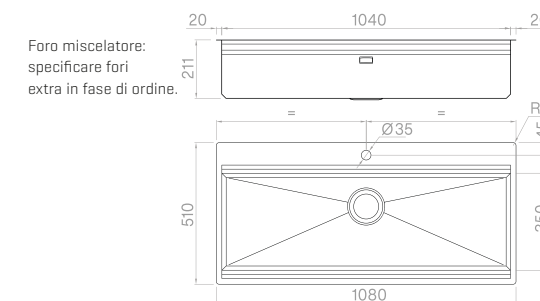

Accessori a pag. 71

LAYER BRP 81 READY



- Tagliere in legno
- Vaschetta forata
- Griglia
- Miscelatore Vertigo

- 5
- 49
- 15
- 47

Sopratop Cod. **SA BRP 81**

LAYER BRP 70 READY



- Tagliere in legno
- Vaschetta forata
- Griglia
- Miscelatore Vertigo

- 5
- 22
- 15
- 47

Sopratop Cod. **SA BRP 70**

LAYER BRP 81 PRO



- Tagliere in legno
- Vaschetta forata

- 5
- 49

Sopratop Cod. **SB BRP 81**

LAYER BRP 70 PRO



- Tagliere in legno
- Vaschetta forata

- 5
- 22

Sopratop Cod. **SB BRP 70**

LAYER BRP 81 SOLO



- | | |
|------------------|--------------|
| Materiale | AISI 304 |
| Finitura | Spazzolato |
| Raggio interno | Raggio '0' |
| Misure esterne | 860 x 510 mm |
| Misure vasca | 810 x 350 mm |
| Profondità vasca | 210 mm |
| Piletta Plus | 3 1/2" |
| Base | 900 mm |

Sopratop Cod. **AL BRP 81**

LAYER BRP 70 SOLO



- | | |
|------------------|--------------|
| Materiale | AISI 304 |
| Finitura | Spazzolato |
| Raggio interno | Raggio '0' |
| Misure esterne | 740 x 510 mm |
| Misure vasca | 700 x 350 mm |
| Profondità vasca | 210 mm |
| Piletta Plus | 3 1/2" |
| Base | 800 mm |

Sopratop Cod. **AL BRP 70**

Foro miscelatore: specificare fori extra in fase di ordine.

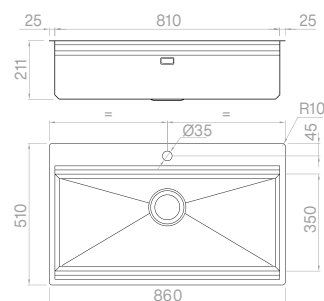

Accessori a pag. 71

Foro miscelatore: specificare fori extra in fase di ordine.

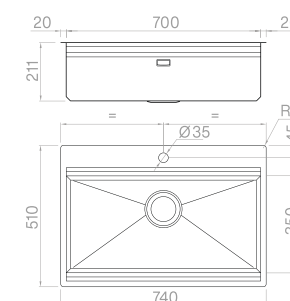

Accessori a pag. 71

LAYER BRP 65 **READY**

Tagliere in legno
 Vaschetta forata
 Miscelatore Vertigo

5
 22
 47



Cod. **SA BRP 65**

LAYER BRP 65 **PRO**

Tagliere in legno

5



Cod. **SB BRP 65**

LAYER BRP 65 **SOLO**

Materiale	AISI 304
Finitura	Spazzolato
Raggio interno	Raggio '0'
Misure esterne	690 x 510 mm
Misure vasca	650 x 350 mm
Profondità vasca	210 mm
Piletta Plus	3 ½"
Base	750 mm



Cod. **AL BRP 65**

Foro miscelatore:
 specificare fori extra
 in fase di ordine.

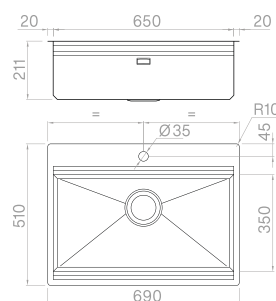

Accessori a pag. 71

LAYER BRP 50 **READY**

Tagliere in legno
 Vaschetta forata
 Miscelatore Vertigo

5
 22
 47



Cod. **SA BRP 50**

LAYER BRP 50 **PRO**

Tagliere in legno

5



Cod. **SB BRP 50**

LAYER BRP 50 **SOLO**

Materiale	AISI 304
Finitura	Spazzolato
Raggio interno	Raggio '0'
Misure esterne	540 x 510 mm
Misure vasca	500 x 350 mm
Profondità vasca	210 mm
Piletta Plus	3 ½"
Base	600 mm



Cod. **AL BRP 50**

Foro miscelatore:
 specificare fori extra
 in fase di ordine.

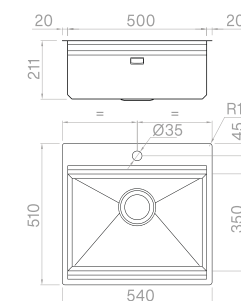

Accessori a pag. 71

Livello superiore



Tagliere in legno acacia

5

300x405x25 mm
Cod. **TSBR 4030**



Griglia

15

300x405x25 mm
Cod. **GFL 4030**



Tagliere in PaperStone®

57

300x405x20 mm
Cod. **TPBR 4030**



Set tagliere + gastronorm

31

300x405x100 mm
Cod. **TPLB 3V**



Set tagliere + colapasta

33

300x405x100 mm
Cod. **TPLB 1S**



Set tagliere + telaio porta coltelli

35

300x405x20 mm
Cod. **TPLB 4030**



Porta piatti

37

250x400x55 mm
Cod. **PPPB SBR**



Livello inferiore



Vaschetta forata

22

190x375x80 mm
Cod. **VFP SBR19**



Vaschetta

29

300x375x160 mm
Cod. **VGS BR34**



Vaschetta forata

49

300x375x80 mm
Cod. **VFG SBR34**





INTEGRATI

LINEA

La caratteristica di Linea è l'esclusiva installazione Edgeless, dove la vasca e il piano si incontrano con un bordo ridotto al minimo, massimizzando estetica e pulizia.



LINEA 70

READY



- Tagliere in legno
- Vaschetta inclinata forata
- Vaschetta
- Miscelatore Element

- 3
- 23
- 26
- 40

Edgeless

Cod. **SAL 70**

LINEA 70

PRO



- Vaschetta forata

- 16

Edgeless

Cod. **SBL 70**

LINEA 70

SOLO



- | | |
|------------------|---------------|
| Materiale | AISI 304 |
| Finitura | Spazzolato |
| Raggio interno | Saldato 10 mm |
| Misure esterne | - |
| Misure vasca | 700 x 400 mm |
| Profondità vasca | 200 mm |
| Piletta standard | 3 ½" |
| Base | 800 mm |

Edgeless

Cod. **L 70**

Accessori a pag. 83

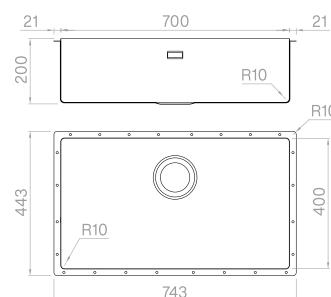

LINEA 65

READY



- Tagliere in legno
- Vaschetta inclinata forata
- Miscelatore Uber

- 3
- 23
- 46

Edgeless

Cod. **SAL 65**

LINEA 65

PRO



- Vaschetta forata

- 16

Edgeless

Cod. **SBL 65**

LINEA 65

SOLO



- | | |
|------------------|---------------|
| Materiale | AISI 304 |
| Finitura | Spazzolato |
| Raggio interno | Saldato 10 mm |
| Misure esterne | - |
| Misure vasca | 650 x 400 mm |
| Profondità vasca | 200 mm |
| Piletta standard | 3 ½" |
| Base | 750 mm |

Edgeless

Cod. **L 65**

Accessori a pag. 83

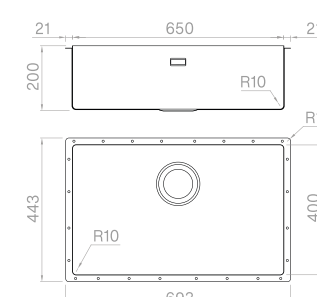

LINEA 50 **READY**



- Tagliere in legno
- Vaschetta inclinata forata
- Miscelatore Uber

3
23
46

Edgeless

Cod. **SAL 50**

LINEA 50 **PRO**



- Vaschetta forata

16

Edgeless

Cod. **SBL 50**

LINEA 50 **SOLO**



- | | |
|------------------|---------------|
| Materiale | AISI 304 |
| Finitura | Spazzolato |
| Raggio interno | Saldato 10 mm |
| Misure esterne | - |
| Misure vasca | 500 x 400 mm |
| Profondità vasca | 200 mm |
| Piletta standard | 3 ½" |
| Base | 600 mm |

Edgeless

Cod. **L 50**

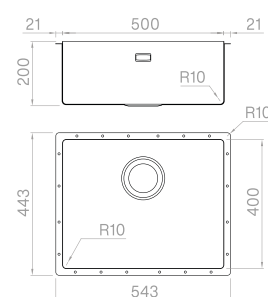

Accessori a pag. 83

LINEA 45 **READY**

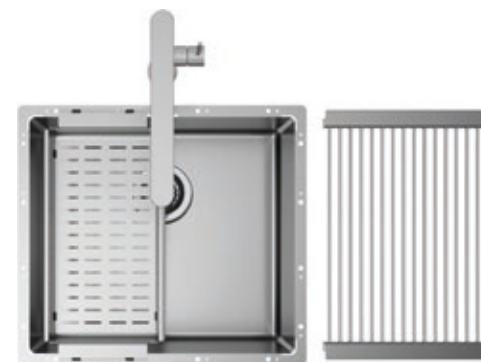

- Griglia
- Vaschetta forata
- Miscelatore Uber

12
16
46

Edgeless

Cod. **SAL 45**

LINEA 45 **PRO**



- Vaschetta forata

16

Edgeless

Cod. **SBL 45**

LINEA 45 **SOLO**



- | | |
|------------------|---------------|
| Materiale | AISI 304 |
| Finitura | Spazzolato |
| Raggio interno | Saldato 10 mm |
| Misure esterne | - |
| Misure vasca | 450 x 400 mm |
| Profondità vasca | 200 mm |
| Piletta standard | 3 ½" |
| Base | 600 mm |

Edgeless

Cod. **L 45**

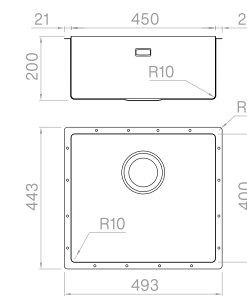

Accessori a pag. 83

LINEA 40 READY

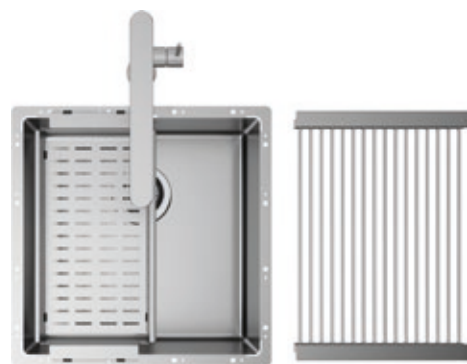

- Griglia
- Vaschetta forata
- Miscelatore Uber

12
16
46



Cod. **SAL 40**

LINEA 40 PRO



- Vaschetta forata

16



Cod. **SBL 40**

LINEA 40 SOLO



- | | |
|------------------|---------------|
| Materiale | AISI 304 |
| Finitura | Spazzolato |
| Raggio interno | Saldato 10 mm |
| Misure esterne | - |
| Misure vasca | 400 x 400 mm |
| Profondità vasca | 200 mm |
| Piletta standard | 3 ½" |
| Base | 450 mm |



Cod. **L 40**

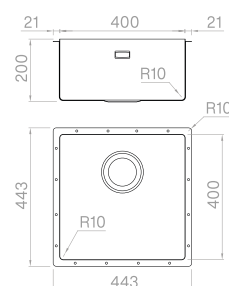

Accessori a pag. 83

LINEA 34 READY

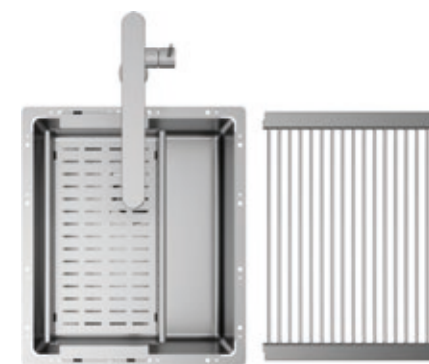

- Griglia
- Vaschetta forata
- Miscelatore Uber

12
16
46



Cod. **SAL 34**

LINEA 34 PRO



- Vaschetta forata

16



Cod. **SBL 34**

LINEA 34 SOLO



- | | |
|------------------|---------------|
| Materiale | AISI 304 |
| Finitura | Spazzolato |
| Raggio interno | Saldato 10 mm |
| Misure esterne | - |
| Misure vasca | 340 x 400 mm |
| Profondità vasca | 200 mm |
| Piletta standard | 3 ½" |
| Base | 450 mm |



Cod. **L 34**

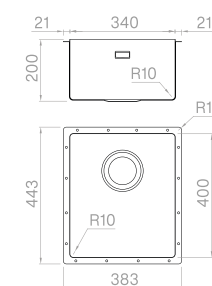

Accessori a pag. 83

Tagliere in legno rovere
3

 300x420x20 mm
 Cod. **TRIB 3042**

Tagliere in HDPE
6

 240x420x20 mm
 Cod. **TRP 2442**

Tagliere in PaperStone®
54

 300x420x20 mm
 Cod. **TRPS 3042**

Griglia
12

 250x420x25 mm
 Cod. **GRS 2542**

Vaschetta forata
16

 210x420x60 mm
 Cod. **VQSF 2142**

Vaschetta inclinata forata
23

 280x420x110/60 mm
 Cod. **VQSI 2842**

Vaschetta
26

 280x420x160 mm
 Cod. **VQSP 2842**

Set gastronorm
30

 240x420x100 mm
 Cod. **TI 2442 V**

Set scolapasta
32

 240x420x20 mm
 Cod. **TI 2442 1S**

Set grattugie
34

 200x420x70 mm
 Cod. **TI 2442 PG**

Portapiatti
36

 250x420x55 mm
 Cod. **PPPB V400**

Goggiolatoio
61

 340x420x30 mm
 Cod. **VQSI 3442**

SHORE

Shore presenta l'innovativa installazione con pareti in continuità al piano di lavoro e il fondo in acciaio inox a vista dall'esclusivo perimetro inclinato a 45°.



SHORE 70

READY



- Tagliere in legno
- Vaschetta inclinata forata
- Miscelatore Element

3
23
40

Integrato 12 mm Cod. **SASH 70**

SHORE 70

PRO



- Vaschetta forata

16

Integrato 12 mm Cod. **SBSH 70**

SHORE 70

SOLO



- | | |
|------------------|--------------|
| Materiale | AISI 304 |
| Finitura | Spazzolato |
| Raggio interno | Saldato 0 mm |
| Misure esterne | 766 x 466 mm |
| Misure vasca | 700 x 400 mm |
| Profondità vasca | 175 mm |
| Piletta standard | 3 1/2" |
| Base | 800 mm |

Integrato 12 mm Cod. **SH 70**

Accessori a pag. 93

20 mm Su richiesta

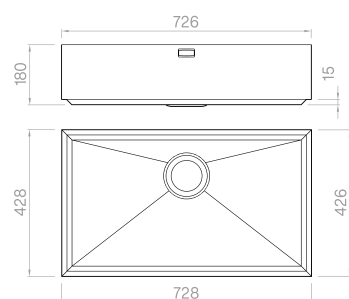

SHORE 65

READY



- Tagliere in legno
- Vaschetta inclinata forata
- Miscelatore Element

3
23
40

Integrato 12 mm Cod. **SASH 65**

SHORE 65

PRO



- Vaschetta forata

16

Integrato 12 mm Cod. **SBSH 65**

SHORE 65

SOLO



- | | |
|------------------|--------------|
| Materiale | AISI 304 |
| Finitura | Spazzolato |
| Raggio interno | Saldato 0 mm |
| Misure esterne | 716 x 466 mm |
| Misure vasca | 650 x 400 mm |
| Profondità vasca | 175 mm |
| Piletta standard | 3 1/2" |
| Base | 750 mm |

Integrato 12 mm Cod. **SH 65**

Accessori a pag. 93

20 mm Su richiesta

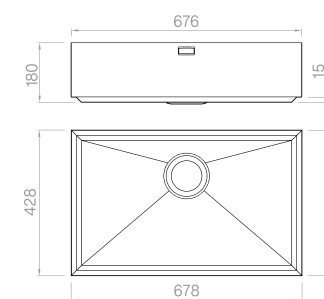

SHORE 50

READY



- Tagliere in legno
- Vaschetta inclinata forata
- Miscelatore Element

3
23
40

Integrato 12 mm Cod. **SASH 50**

SHORE 50

PRO



- Vaschetta forata

16

Integrato 12 mm Cod. **SBSH 50**

SHORE 50

SOLO



- | | |
|------------------|--------------|
| Materiale | AISI 304 |
| Finitura | Spazzolato |
| Raggio interno | Saldato 0 mm |
| Misure esterne | 566 x 466 mm |
| Misure vasca | 500 x 400 mm |
| Profondità vasca | 175 mm |
| Piletta standard | 3 1/2" |
| Base | 600 mm |

Integrato 12 mm Cod. **SH 50**

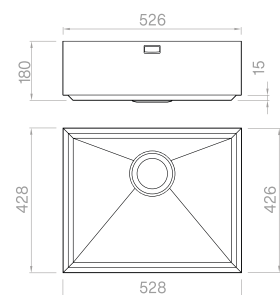

Accessori a pag. 93

Integrato 20 mm Su richiesta

SHORE 45

READY



- Griglia
- Vaschetta forata
- Miscelatore Uber

12
16
46

Integrato 12 mm Cod. **SASH 45**

SHORE 45

PRO



- Vaschetta forata

16

Integrato 12 mm Cod. **SBSH 45**

SHORE 45

SOLO



- | | |
|------------------|--------------|
| Materiale | AISI 304 |
| Finitura | Spazzolato |
| Raggio interno | Saldato 0 mm |
| Misure esterne | 516 x 466 mm |
| Misure vasca | 450 x 400 mm |
| Profondità vasca | 175 mm |
| Piletta standard | 3 1/2" |
| Base | 600 mm |

Integrato 12 mm Cod. **SH 45**

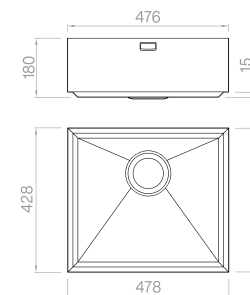

Accessori a pag. 93

Integrato 20 mm Su richiesta

SHORE 40 + 34

READY

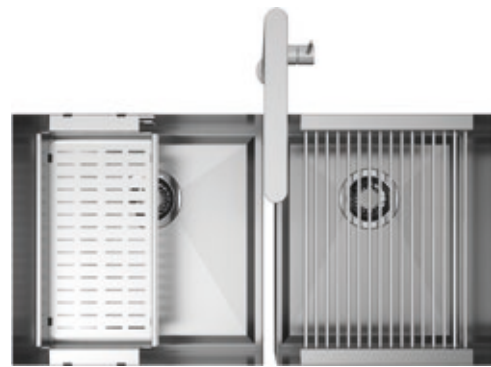

- Griglia
- Vaschetta forata
- Miscelatore Uber

12
16
46

 Integrato 12 mm Cod. **SASH 40**

SHORE 34 + 34

READY

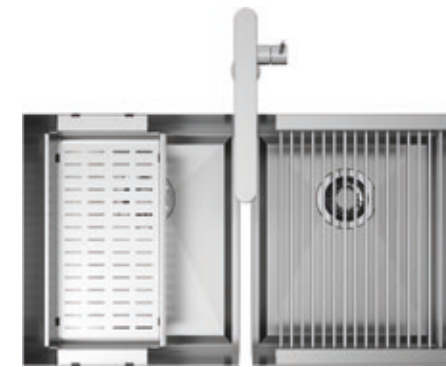

- Griglia
- Vaschetta forata
- Miscelatore Uber

12
16
46

 Integrato 12 mm Cod. **SASH 34**

SHORE 40

PRO



- Vaschetta forata

16

 Integrato 12 mm Cod. **SBSH 40**

SHORE 34

PRO



- Vaschetta forata

16

 Integrato 12 mm Cod. **SBSH 34**

SHORE 40

SOLO



- | | |
|------------------|--------------|
| Materiale | AISI 304 |
| Finitura | Spazzolato |
| Raggio interno | Saldato 0 mm |
| Misure esterne | 466 x 466 mm |
| Misure vasca | 400 x 400 mm |
| Profondità vasca | 175 mm |
| Piletta standard | 3 ½" |
| Base | 600 mm |

 Integrato 12 mm Cod. **SH 40**

SHORE 34

SOLO



- | | |
|------------------|--------------|
| Materiale | AISI 304 |
| Finitura | Spazzolato |
| Raggio interno | Saldato 0 mm |
| Misure esterne | 406 x 466 mm |
| Misure vasca | 340 x 400 mm |
| Profondità vasca | 175 mm |
| Piletta standard | 3 ½" |
| Base | 450 mm |

 Integrato 12 mm Cod. **SH 34**

Accessori a pag. 93

 **20 mm** Su richiesta

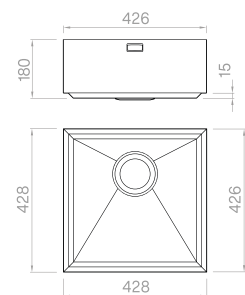

Accessori a pag. 93

Accessori a pag. 93

 **20 mm** Su richiesta

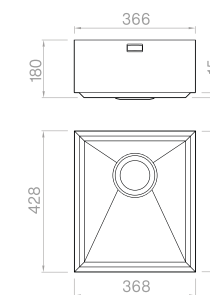

Tagliere in legno rovere

3

300x420x20 mm

Cod. **TRIB 3042**

Tagliere in HDPE

6

240x420x20 mm

Cod. **TRP 2442**

Tagliere in PaperStone®

54

300x420x20 mm

Cod. **TRPS 3042**

Griglia

12

250x420x25 mm

Cod. **GRS 2542**

Vaschetta forata

16

210x420x60 mm

Cod. **VQSF 2142**

Vaschetta inclinata forata

23

280x420x110/60 mm

Cod. **VQSI 2842**

Vaschetta

26

280x420x160 mm

Cod. **VQSP 2842**

Set gastronorm

30

240x420x100 mm

Cod. **TI 2442 V**

Set scolapasta

32

240x420x20 mm

Cod. **TI 2442 1S**

Set grattugie

34

200x420x70 mm

Cod. **TI 2442 PG**

Portapiatti

36

250x420x55 mm

Cod. **PPPB V400**

Goggiolatoio

61

340x420x30 mm

Cod. **VQSI 3442**



SINKS



TITANIUM

Lo speciale trattamento PVD è una tecnologia atossica e resistente che permette di virare il colore dell'acciaio inox. Nelle tre finiture esclusive Artinox - Gun Metal, Copper Bronze e Pale Gold - sono applicate soluzioni monocromatiche dall'altissimo impatto estetico.

TITANIUM GUN METAL



TITANIUM 70 GUN METAL

READY

Vaschetta forata Gun Metal
Miscelatore Athom

17
42

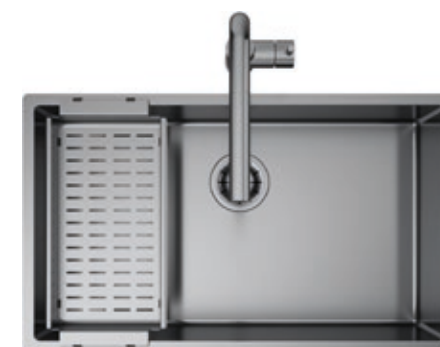

 Sopratop
 Filotop
 Sottotop

Cod. **SAT I 70 RA**
 Cod. **SATG 70 RA**
 Cod. **SATO 70 RA**

TITANIUM 70 GUN METAL

PRO

Vaschetta forata Gun Metal

17





 Sopratop
 Filotop
 Sottotop

Cod. **SBT I 70 RA**
 Cod. **SBTG 70 RA**
 Cod. **SBTO 70 RA**

TITANIUM 70 GUN METAL

SOLO



Materiale	AISI 304
Finitura	PVD Gun Metal
Raggio interno	Saldato 10 mm
Misure esterne	740 x 440 mm
Misure vasca	700 x 400 mm
Profondità vasca	200 mm
Piletta Plus Gun Metal	3 1/2"
Base	800 mm
 Sopratop	Cod. TI 7040 RA
 Filotop	Cod. TG 7040 RA
 Sottotop	Cod. TO 7040 RA

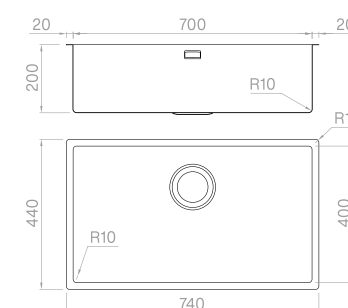

Accessori a pag. 101

TITANIUM 50 GUN METAL

READY



Vaschetta forata Gun Metal
Miscelatore Athom

17
42

— Sopratop
— Filotop
— Sottotop

Cod. **SAT I 50 RA**
Cod. **SATG 50 RA**
Cod. **SATO 50 RA**

TITANIUM 50 GUN METAL

PRO



Vaschetta forata Gun Metal

17

— Sopratop
— Filotop
— Sottotop

Cod. **SBT I 50 RA**
Cod. **SBTG 50 RA**
Cod. **SBTO 50 RA**

TITANIUM 50 GUN METAL

SOLO



Materiale	AISI 304
Finitura	PVD Gun Metal
Raggio interno	Saldato 10 mm
Misure esterne	540 x 440 mm
Misure vasca	500 x 400 mm
Profondità vasca	200 mm
Piletta Plus Gun Metal	3 ½"
Base	600 mm

— Sopratop
— Filotop
— Sottotop

Cod. **TI 5040 RA**
Cod. **TG 5040 RA**
Cod. **TO 5040 RA**

Accessori a pag. 101

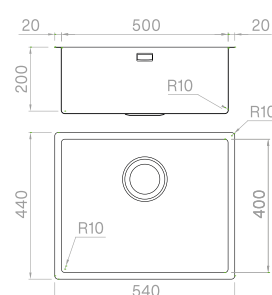

Tagliere in legno rovere

3

300x420x20 mm
Cod. **TRIB 3042**



Tagliere in HDPE

6

240x420x20 mm
Cod. **TRP 2442**



Tagliere in PaperStone®

73

200x420x19 mm
Cod. **TRPS 2042**



Vaschetta forata Gun Metal

17

210x420x60 mm
Cod. **VQAF 2142**

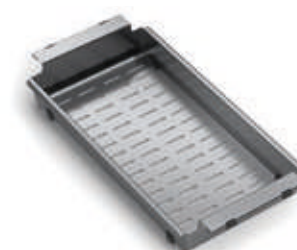

Set gastronorm PaperStone®

76

240x420x20 mm
Cod. **TI 2442 VP**



Set scolapasta PaperStone®

77

240x420x20 mm
Cod. **TI 2442 SP**



Set grattugie PaperStone®

75

200x420x20 mm
Cod. **TI 2442 GP**



TITANIUM COPPER BRONZE



TITANIUM 70 COPPER BRONZE

READY

Vaschetta forata Copper Bronze
 Miscelatore Athom

18
 43

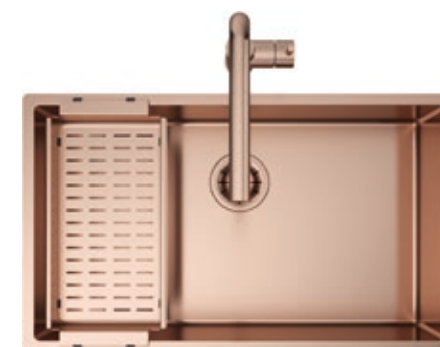

☐ Sopratop
 ☐ Filotop
 ☐ Sottotop

Cod. **SAT I 70 RC**
 Cod. **SATG 70 RC**
 Cod. **SATO 70 RC**

TITANIUM 70 COPPER BRONZE

PRO

Vaschetta forata Copper Bronze

18



☐ Sopratop
 ☐ Filotop
 ☐ Sottotop

Cod. **SBT I 70 RC**
 Cod. **SBTG 70 RC**
 Cod. **SBTO 70 RC**

TITANIUM 70 COPPER BRONZE

SOLO

Materiale	AISI 304
Finitura	PVD Copper Bronze
Raggio interno	Saldato 10 mm
Misure esterne	740 x 440 mm
Misure vasca	700 x 400 mm
Profondità vasca	200 mm
Piletta Plus Copper Bronze	3 1/2"
Base	800 mm
☐ Sopratop	Cod. TI 7040 RC
☐ Filotop	Cod. TG 7040 RC
☐ Sottotop	Cod. TO 7040 RC

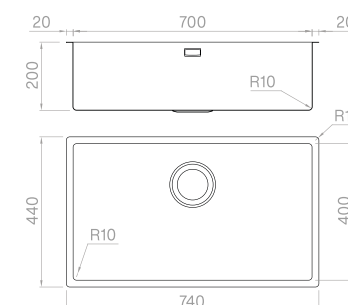

Accessori a pag. 105

TITANIUM 50 COPPER BRONZE

READY



Vaschetta forata Copper Bronze
Miscelatore Athom

18

43

Cod. **SAT I 50 RC**Cod. **SATG 50 RC**Cod. **SATO 50 RC**

TITANIUM 50 COPPER BRONZE

PRO



Vaschetta forata Copper Bronze

18

Cod. **SBT I 50 RC**Cod. **SBTG 50 RC**Cod. **SBTO 50 RC**

TITANIUM 50 COPPER BRONZE

SOLO



Materiale	AISI 304
Finitura	PVD Copper Bronze
Raggio interno	Saldato 10 mm
Misure esterne	540 x 440 mm
Misure vasca	500 x 400 mm
Profondità vasca	200 mm
Piletta Plus Copper Bronze	3 ½"
Base	600 mm

Cod. **TI 5040 RC**Cod. **TG 5040 RC**Cod. **TO 5040 RC**

Accessori a pag. 105

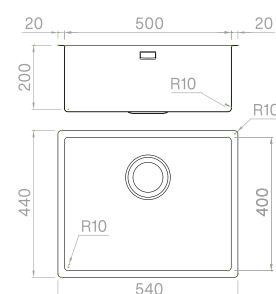

Tagliere in legno rovere

3

300x420x20 mm
Cod. **TRIB 3042**



Tagliere in HDPE

6

240x420x20 mm
Cod. **TRP 2442**



Tagliere in PaperStone®

73

200x420x19 mm
Cod. **TRPS 2042**



Vaschetta forata Copper Bronze

18

210x420x60 mm
Cod. **VQCF 2142**



Set gastronom PaperStone®

76

200x420x20 mm
Cod. **TI 2442 VP**



Set scolapasta PaperStone®

77

200x420x20 mm
Cod. **TI 2442 SP**



Set grattugie PaperStone®

75

200x420x20 mm
Cod. **TI 2442 GP**



TITANIUM PALE GOLD



TITANIUM 70 PALE GOLD

READY

Vaschetta forata Pale Gold
Miscelatore Athom

19

44

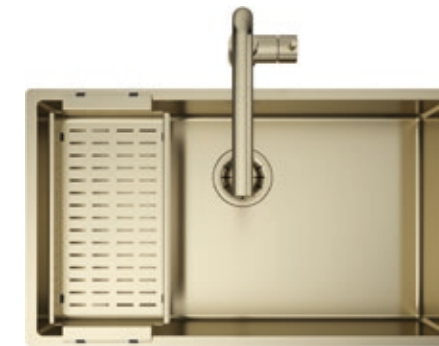

 Sopratop
 Filotop
 Sottotop

Cod. **SAT I 70 RG**Cod. **SATG 70 RG**Cod. **SATO 70 RG**

TITANIUM 70 PALE GOLD

PRO

Vaschetta forata Pale Gold

19





 Sopratop
 Filotop
 Sottotop

Cod. **SBT I 70 RG**Cod. **SBTG 70 RG**Cod. **SBTO 70 RG**

TITANIUM 70 PALE GOLD

SOLO



Materiale	AISI 304
Finitura	PVD Pale Gold
Raggio interno	Saldato 10 mm
Misure esterne	740 x 440 mm
Misure vasca	700 x 400 mm
Profondità vasca	200 mm
Piletta Plus Pale Gold	3 1/2"
Base	800 mm
 Sopratop	Cod. TI 7040 RG
 Filotop	Cod. TG 7040 RG
 Sottotop	Cod. TO 7040 RG

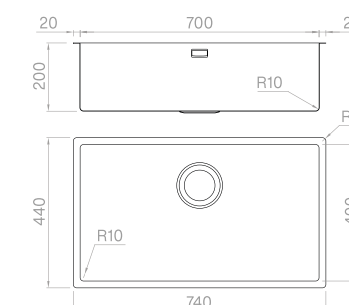

Accessori a pag. 109

TITANIUM 50 PALE GOLD

READY



Vaschetta forata Pale Gold
Miscelatore Athom

19

44

- Sopratop
- Filotop
- Sottotop

Cod. **SAT I 50 RG**Cod. **SATG 50 RG**Cod. **SATO 50 RG**

TITANIUM 50 PALE GOLD

PRO



Vaschetta forata Pale Gold

19

- Sopratop
- Filotop
- Sottotop

Cod. **SBT I 50 RG**Cod. **SBTG 50 RG**Cod. **SBTO 50 RG**

TITANIUM 50 PALE GOLD

SOLO



Materiale	AISI 304
Finitura	PVD Pale Gold
Raggio interno	Saldato 10 mm
Misure esterne	540 x 440 mm
Misure vasca	500 x 400 mm
Profondità vasca	200 mm
Piletta Plus Pale Gold	3 1/2"
Base	600 mm

- Sopratop
- Filotop
- Sottotop

Cod. **TI 5040 RG**Cod. **TG 5040 RG**Cod. **TO 5040 RG**

Accessori a pag. 109

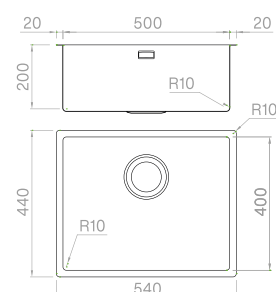

Tagliere in legno rovere

3

300x420x20 mm

Cod. **TRIB 3042**

Tagliere in HDPE

6

240x420x20 mm

Cod. **TRP 2442**

Tagliere in PaperStone®

73

200x420x19 mm

Cod. **TRPS 2042**

Vaschetta forata Pale Gold

19

210x420x60 mm

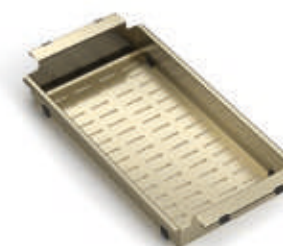
Cod. **VQGF 2142**

Set gastronorm PaperStone®

76

200x420x20 mm

Cod. **TI 2442 VP**

Set scolapasta PaperStone®

77

200x420x20 mm

Cod. **TI 2442 SP**

Set grattugie PaperStone®

75

200x420x20 mm

Cod. **TI 2442 GP**

RADIUS



RADIUS MATTE VINTAGE

Un lavello elegante e sofisticato grazie all'abbinamento fra l'acciaio Matte Vintage e la finitura nera dei miscelatori e degli accessori. Il Matte Vintage è un'esclusiva Artinox caratterizzata da una superficie non uniforme che esalta la matericità dell'acciaio inossidabile.



RADIUS MATTE VINTAGE 70

READY



Griglia
Vaschetta inclinata forata
Miscelatore Ergo

13
24
41

 Sopratop
 Filotop
 Sottotop

Cod. **SAB I 70 RH**
 Cod. **SABG 70 RH**
 Cod. **SABO 70 RH**

RADIUS MATTE VINTAGE 70

PRO



Vaschetta inclinata forata

24

 Sopratop
 Filotop
 Sottotop

Cod. **SBB I 70 RH**
 Cod. **SBBG 70 RH**
 Cod. **SBBO 70 RH**

RADIUS MATTE VINTAGE 70

SOLO



Materiale	AISI 304
Finitura	Spazzolato opaco
Raggio interno	Saldato 10 mm
Misure esterne	740 x 440 mm
Misure vasca	700 x 400 mm
Profondità vasca	200 mm
Piletta nera	3 1/2"
Base	800 mm

 Sopratop
 Filotop
 Sottotop

Cod. **BI 7040 RH**
 Cod. **BG 7040 RH**
 Cod. **BO 7040 RH**

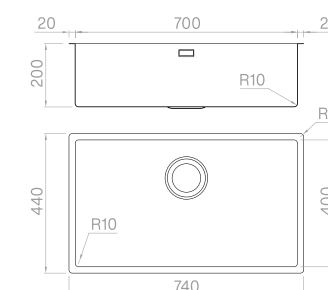

Accessori a pag. 117

RADIUS MATTE VINTAGE 50

READY

Vaschetta inclinata forata
Miscelatore Ergo

24
41



Cod. **SAB I 50 RH**
Cod. **SABG 50 RH**
Cod. **SABO 50 RH**

RADIUS MATTE VINTAGE 50

PRO

Vaschetta inclinata forata

24



Cod. **SBB I 50 RH**
Cod. **SBBG 50 RH**
Cod. **SBBO 50 RH**

RADIUS MATTE VINTAGE 50

SOLO

Materiale	AISI 304
Finitura	Spazzolato opaco
Raggio interno	Saldato 10 mm
Misure esterne	540 x 440 mm
Misure vasca	500 x 400 mm
Profondità vasca	200 mm
Piletta nera	3 ½"
Base	600 mm



Cod. **BI 5040 RH**
Cod. **BG 5040 RH**
Cod. **BO 5040 RH**

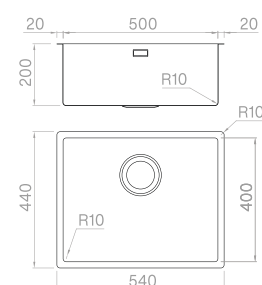

Accessori a pag. 117

RADIUS MATTE VINTAGE 40

READY

Vaschetta inclinata forata
Miscelatore Ergo

24
41



Cod. **SAB I 40 RH**
Cod. **SABG 40 RH**
Cod. **SABO 40 RH**

RADIUS MATTE VINTAGE 40

PRO

Vaschetta inclinata forata

24



Cod. **SBB I 40 RH**
Cod. **SBBG 40 RH**
Cod. **SBBO 40 RH**

RADIUS MATTE VINTAGE 40

SOLO

Materiale	AISI 304
Finitura	Spazzolato opaco
Raggio interno	Saldato 10 mm
Misure esterne	440 x 440 mm
Misure vasca	400 x 400 mm
Profondità vasca	200 mm
Piletta nera	3 ½"
Base	600 mm



Cod. **BI 4040 RH**
Cod. **BG 4040 RH**
Cod. **BO 4040 RH**

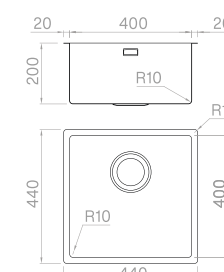

Accessori a pag. 117



Tagliere in legno rovere

3

300x420x20 mm
Cod. **TRIB 3042**



Tagliere PaperStone®

73

200x420x19 mm
Cod. **TRPS 2042**



Tagliere in PaperStone®

54

300x420x20 mm
Cod. **TRPS 3042**



Griglia matte vintage

13

250x420x25 mm
Cod. **GRH 2542**



Vaschetta inclinata forata
matte vintage

24

280x420x110/60 mm
Cod. **VQHI 2842**



Set grattugie PaperStone®

75

200x420x20 mm
Cod. **TI 2442 GP**



Set gastronorm PaperStone®

76

200x420x20 mm
Cod. **TI 2442 VP**



Set scolapasta PaperStone®

77

200x420x20 mm
Cod. **TI 2442 SP**



RADIUS

La collezione Radius ha un'ampia scelta di lavelli, realizzati con angoli interni raggio 10 mm. La precisione si somma all'essenzialità delle geometrie.



RADIUS 81

READY



Tagliere in legno
Vaschetta inclinata forata
Vaschetta
Miscelatore Element

3
23
26
40

Sopratop
 Filotop
 Sottotop

Cod. **SAB I 81 R1**
 Cod. **SABG 81 R1**
 Cod. **SABO 81 R1**

RADIUS 81

PRO



Vaschetta forata

16

Sopratop
 Filotop
 Sottotop

Cod. **SBB I 81 R1**
 Cod. **SBBG 81 R1**
 Cod. **SBBO 81 R1**

RADIUS 81

SOLO



Materiale	AISI 304
Finitura	Spazzolato
Raggio interno	Saldato 10 mm
Misure esterne	850 x 440 mm
Misure vasca	810 x 400 mm
Profondità vasca	200 mm
Piletta standard	3 1/2"
Base	900 mm

Sopratop
 Filotop
 Sottotop

Cod. **BI 8140 R1**
 Cod. **BG 8140 R1**
 Cod. **BO 8140 R1**

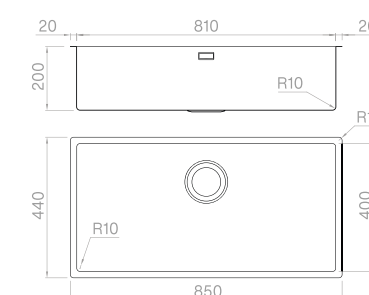

Accessori a pag. 127

RADIUS 70 READY



Tagliere in legno
 Vaschetta inclinata forata
 Vaschetta
 Miscelatore Element

3
 23
 26
 40

Sopratop
 Filotop
 Sottotop

Cod. **SAB I 70 R1**
 Cod. **SABG 70 R1**
 Cod. **SABO 70 R1**

RADIUS 65 READY



Tagliere in legno
 Vaschetta inclinata forata
 Miscelatore Hero

3
 23
 39

Sopratop
 Filotop
 Sottotop

Cod. **SAB I 65 R1**
 Cod. **SABG 65 R1**
 Cod. **SABO 65 R1**

RADIUS 70 PRO



Vaschetta forata

16

Sopratop
 Filotop
 Sottotop

Cod. **SBB I 70 R1**
 Cod. **SBBG 70 R1**
 Cod. **SBBO 70 R1**

RADIUS 65 PRO



Vaschetta forata

16

Sopratop
 Filotop
 Sottotop

Cod. **SBB I 65 R1**
 Cod. **SBBG 65 R1**
 Cod. **SBBO 65 R1**

RADIUS 70 SOLO



Materiale	AISI 304
Finitura	Spazzolato
Raggio interno	Saldato 10 mm
Misure esterne	740 x 440 mm
Misure vasca	700 x 400 mm
Profondità vasca	200 mm
Piletta standard	3 ½"
Base	800 mm

Sopratop
 Filotop
 Sottotop

Cod. **BI 7040 R1**
 Cod. **BG 7040 R1**
 Cod. **BO 7040 R1**

RADIUS 65 SOLO



Materiale	AISI 304
Finitura	Spazzolato
Raggio interno	Saldato 10 mm
Misure esterne	690 x 440 mm
Misure vasca	650 x 400 mm
Profondità vasca	200 mm
Piletta standard	3 ½"
Base	750 mm

Sopratop
 Filotop
 Sottotop

Cod. **BI 6540 R1**
 Cod. **BG 6540 R1**
 Cod. **BO 6540 R1**

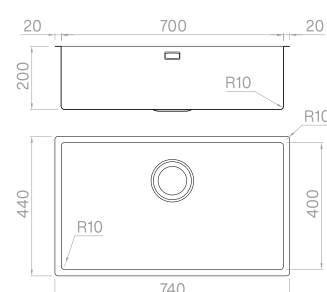

Accessori a pag. 127

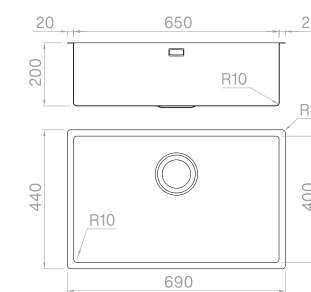

Accessori a pag. 127

RADIUS 55

READY

Tagliere in legno
Vaschetta inclinata forata
Miscelatore Hero

3
23
39



— Sopratop
— Filotop
— Sottotop

Cod. **SAB I 55 R1**
Cod. **SABG 55 R1**
Cod. **SABO 55 R1**

RADIUS 50

READY

Tagliere in legno
Vaschetta inclinata forata
Miscelatore Hero

3
23
39



— Sopratop
— Filotop
— Sottotop

Cod. **SAB I 50 R1**
Cod. **SABG 50 R1**
Cod. **SABO 50 R1**

RADIUS 55

PRO

Vaschetta forata

16



— Sopratop
— Filotop
— Sottotop

Cod. **SBB I 55 R1**
Cod. **SBBG 55 R1**
Cod. **SBBO 55 R1**

RADIUS 50

PRO

Vaschetta forata

16



— Sopratop
— Filotop
— Sottotop

Cod. **SBB I 50 R1**
Cod. **SBBG 50 R1**
Cod. **SBBO 50 R1**

RADIUS 55

SOLO

Materiale AISI 304
Finitura Spazzolato
Raggio interno Saldato 10 mm
Misure esterne 590 x 440 mm
Misure vasca 550 x 400 mm
Profondità vasca 200 mm
Piletta standard 3 ½"
Base 600 mm

— Sopratop
— Filotop
— Sottotop

Cod. **BI 5540 R1**
Cod. **BG 5540 R1**
Cod. **BO 5540 R1**

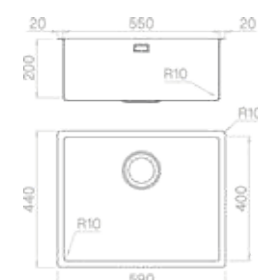

Accessori a pag. 127

RADIUS 50

SOLO

Materiale AISI 304
Finitura Spazzolato
Raggio interno Saldato 10 mm
Misure esterne 540 x 440 mm
Misure vasca 500 x 400 mm
Profondità vasca 200 mm
Piletta standard 3 ½"
Base 600 mm

— Sopratop
— Filotop
— Sottotop

Cod. **BI 5040 R1**
Cod. **BG 5040 R1**
Cod. **BO 5040 R1**

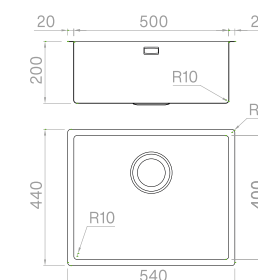

Accessori a pag. 127

RADIUS 45

READY



Griglia
Vaschetta forata
Miscelatore Hero

12
16
39

— Sopratop
— Filotop
— Sottotop

Cod. **SAB I 45 R1**
Cod. **SABG 45 R1**
Cod. **SABO 45 R1**

RADIUS 40 + 34

READY



Griglia
Vaschetta forata
Miscelatore Hero

12
16
39

— Sopratop
— Filotop
— Sottotop

Cod. **SAB I 40 R1**
Cod. **SABG 40 R1**
Cod. **SABO 40 R1**

RADIUS 45

PRO



Vaschetta forata

16

— Sopratop
— Filotop
— Sottotop

Cod. **SBB I 45 R1**
Cod. **SBBG 45 R1**
Cod. **SBBO 45 R1**

RADIUS 40

PRO



Vaschetta forata

16

— Sopratop
— Filotop
— Sottotop

Cod. **SBB I 40 R1**
Cod. **SBBG 40 R1**
Cod. **SBBO 40 R1**

RADIUS 45

SOLO



Materiale AISI 304
Finitura Spazzolato
Raggio interno Saldato 10 mm
Misure esterne 490 x 440 mm
Misure vasca 450 x 400 mm
Profondità vasca 200 mm
Piletta standard 3 ½"
Base 600 mm

— Sopratop
— Filotop
— Sottotop

Cod. **BI 4540 R1**
Cod. **BG 4540 R1**
Cod. **BO 4540 R1**

RADIUS 40

SOLO



Materiale AISI 304
Finitura Spazzolato
Raggio interno Saldato 10 mm
Misure esterne 440 x 440 mm
Misure vasca 400 x 400 mm
Profondità vasca 200 mm
Piletta standard 3 ½"
Base 600 mm

— Sopratop
— Filotop
— Sottotop

Cod. **BI 4040 R1**
Cod. **BG 4040 R1**
Cod. **BO 4040 R1**

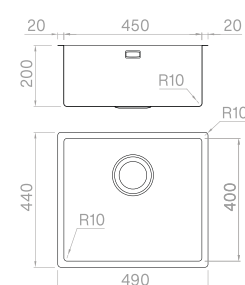

Accessori a pag. 127

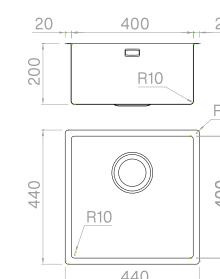

Accessori a pag. 127

RADIUS 34+34

READY

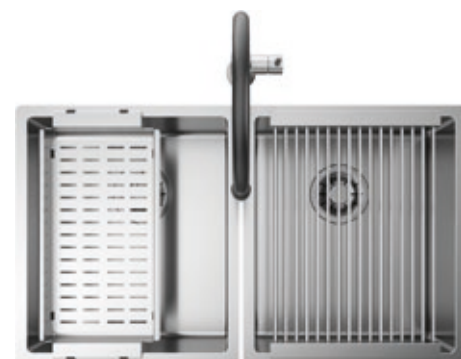

Griglia
Vaschetta forata
Miscelatore Hero

12
16
39

— Sopratop
— Filotop
— Sottotop

Cod. **SAB I 34 R1**
Cod. **SABG 34 R1**
Cod. **SABO 34 R1**

RADIUS 34

PRO



Vaschetta forata

16

— Sopratop
— Filotop
— Sottotop

Cod. **SBB I 34 R1**
Cod. **SBBG 34 R1**
Cod. **SBBO 34 R1**

RADIUS 34

SOLO



Materiale	AISI 304
Finitura	Spazzolato
Raggio interno	Saldato 10 mm
Misure esterne	380 x 440 mm
Misure vasca	340 x 400 mm
Profondità vasca	200 mm
Piletta standard	3 ½"
Base	450 mm

— Sopratop
— Filotop
— Sottotop

Cod. **BI 3440 R1**
Cod. **BG 3440 R1**
Cod. **BO 3440 R1**

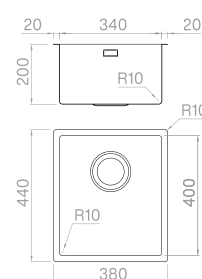

Accessori a pag. 127

Tagliere in legno rovere

3

300x420x20 mm
Cod. **TRIB 3042**



Tagliere in HDPE

6

240x420x20 mm
Cod. **TRP 2442**



Tagliere in PaperStone®

54

300x420x20 mm
Cod. **TRPS 3042**



Griglia

12

250x420x25 mm
Cod. **GRS 2542**



Vaschetta forata

16

210x420x60 mm
Cod. **VQSF 2142**



Vaschetta inclinata forata

23

280x420x110/60 mm
Cod. **VQSI 2842**



Vaschetta

26

280x420x160 mm
Cod. **VQSP 2842**



Set gastronorm PaperStone®

76

200x420x20 mm
Cod. **TI 2442 VP**



Set scolapasta PaperStone®

77

200x420x20 mm
Cod. **TI 2442 SP**



Set grattugie PaperStone®

75

200x420x20 mm
Cod. **TI 2442 GP**



Portapiatti

36

250x420x55 mm
Cod. **PPPB V400**



Goggiolatoio

61

340x420x30 mm
Cod. **VQSI 3442**





PRISMA

Un perfetto connubio tra precisione geometrica e pulizia formale: in Prisma gli angoli delle pareti a raggio zero si uniscono ad un esclusivo fondo dal perimetro inclinato a 45°.

PRISMA 81

READY



Tagliere in legno
 Vaschetta inclinata forata
 Vaschetta
 Miscelatore Element

3
 23
 26
 40

Sopratop
 Filotop
 Sottotop

Cod. **SAPR I 81**Cod. **SAPRG 81**Cod. **SAPRO 81**

PRISMA 81

PRO



Vaschetta forata

16

Sopratop
 Filotop
 Sottotop

Cod. **SBPR I 81**Cod. **SBPRG 81**Cod. **SBPRO 81**

PRISMA 81

SOLO



Materiale AISI 304
 Finitura Spazzolato
 Raggio interno Saldato 0 mm
 Misure esterne 850 x 440 mm
 Misure vasca 810 x 400 mm
 Profondità vasca 200 mm
 Piletta standard 3 1/2"
 Base 900 mm

Sopratop
 Filotop
 Sottotop

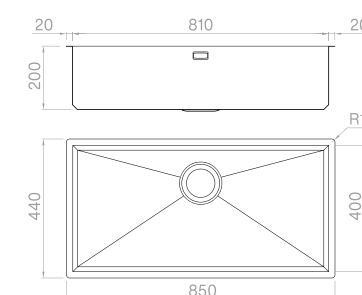
Cod. **PR I 81**Cod. **PR G 81**Cod. **PR O 81**

Accessori a pag. 139



PRISMA 70 READY



Tagliere in legno
 Vaschetta inclinata forata
 Vaschetta
 Miscelatore Element

3
 23
 26
 40

Sopratop
 Filotop
 Sottotop

Cod. **SAPR I 70**
 Cod. **SAPRG 70**
 Cod. **SAPRO 70**

PRISMA 65 READY



Tagliere in legno
 Vaschetta inclinata forata
 Miscelatore Vertigo

3
 23
 47

Sopratop
 Filotop
 Sottotop

Cod. **SAPR I 65**
 Cod. **SAPRG 65**
 Cod. **SAPRO 65**

PRISMA 70 PRO



Vaschetta forata

16

Sopratop
 Filotop
 Sottotop

Cod. **SBPR I 70**
 Cod. **SBPRG 70**
 Cod. **SBPRO 70**

PRISMA 65 PRO



Vaschetta forata

16

Sopratop
 Filotop
 Sottotop

Cod. **SBPR I 65**
 Cod. **SBPRG 65**
 Cod. **SBPRO 65**

PRISMA 70 SOLO



Materiale	AISI 304
Finitura	Spazzolato
Raggio interno	Saldato 0 mm
Misure esterne	740 x 440 mm
Misure vasca	700 x 400 mm
Profondità vasca	200 mm
Piletta standard	3 ½"
Base	800 mm

Sopratop
 Filotop
 Sottotop

Cod. **PR I 70**
 Cod. **PR G 70**
 Cod. **PR O 70**

PRISMA 65 SOLO



Materiale	AISI 304
Finitura	Spazzolato
Raggio interno	Saldato 0 mm
Misure esterne	690 x 440 mm
Misure vasca	650 x 400 mm
Profondità vasca	200 mm
Piletta standard	3 ½"
Base	750 mm

Sopratop
 Filotop
 Sottotop

Cod. **PR I 65**
 Cod. **PR G 65**
 Cod. **PR O 65**

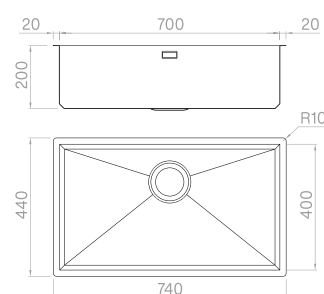

Accessori a pag. 139

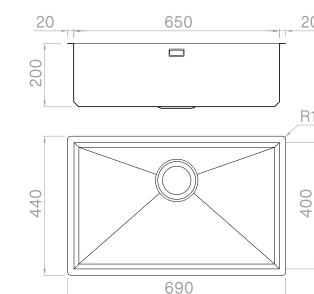

Accessori a pag. 139

PRISMA 50 READY



Tagliere in legno
Vaschetta inclinata forata
Miscelatore Vertigo

3
23
47

 Sopratop
 Filotop
 Sottotop

Cod. **SAPR I 50**
 Cod. **SAPRG 50**
 Cod. **SAPRO 50**

PRISMA 50 PRO



Vaschetta forata

16

 Sopratop
 Filotop
 Sottotop

Cod. **SBPR I 50**
 Cod. **SBPRG 50**
 Cod. **SBPRO 50**

PRISMA 50 SOLO



Materiale	AISI 304
Finitura	Spazzolato
Raggio interno	Saldato 0 mm
Misure esterne	540 x 440 mm
Misure vasca	500 x 400 mm
Profondità vasca	200 mm
Piletta standard	3 ½"
Base	600 mm

 Sopratop
 Filotop
 Sottotop

Cod. **PR I 50**
 Cod. **PR G 50**
 Cod. **PR O 50**

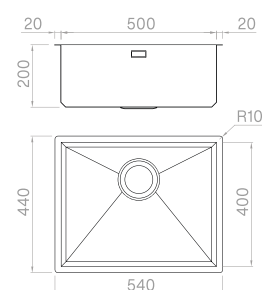

Accessori a pag. 139

PRISMA 45 READY

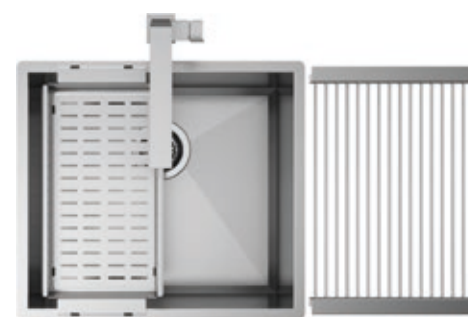

Griglia
Vaschetta forata
Miscelatore Vertigo

12
16
47

 Sopratop
 Filotop
 Sottotop

Cod. **SAPR I 45**
 Cod. **SAPRG 45**
 Cod. **SAPRO 45**

PRISMA 45 PRO



Vaschetta forata

16

 Sopratop
 Filotop
 Sottotop

Cod. **SBPR I 45**
 Cod. **SBPRG 45**
 Cod. **SBPRO 45**

PRISMA 45 SOLO



Materiale	AISI 304
Finitura	Spazzolato
Raggio interno	Saldato 0 mm
Misure esterne	490 x 440 mm
Misure vasca	450 x 400 mm
Profondità vasca	200 mm
Piletta standard	3 ½"
Base	600 mm

 Sopratop
 Filotop
 Sottotop

Cod. **PR I 45**
 Cod. **PR G 45**
 Cod. **PR O 45**

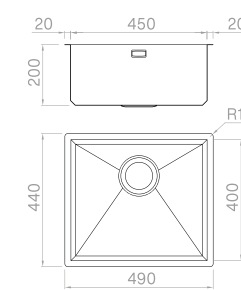

Accessori a pag. 139

PRISMA 40 + 34

READY

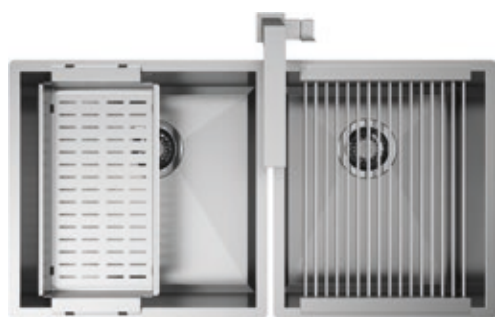

Griglia
Vaschetta forata
Miscelatore Vertigo

12
16
47

— Sopratop
— Filotop
— Sottotop

Cod. **SAPR I 40**
Cod. **SAPRG 40**
Cod. **SAPRO 40**

PRISMA 34 + 34

READY

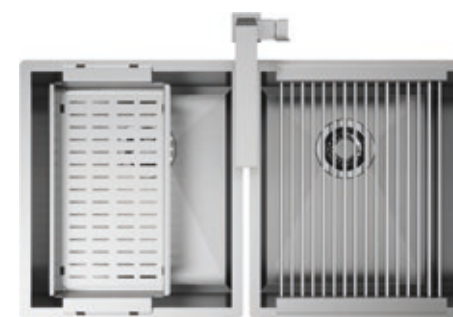

Griglia
Vaschetta forata
Miscelatore Vertigo

12
16
47

— Sopratop
— Filotop
— Sottotop

Cod. **SAPR I 34**
Cod. **SAPRG 34**
Cod. **SAPRO 34**

PRISMA 40

PRO

Vaschetta forata

16



— Sopratop
— Filotop
— Sottotop

Cod. **SBPR I 40**
Cod. **SBPRG 40**
Cod. **SBPRO 40**

PRISMA 34

PRO

Vaschetta forata

16



— Sopratop
— Filotop
— Sottotop

Cod. **SBPR I 34**
Cod. **SBPRG 34**
Cod. **SBPRO 34**

PRISMA 40

SOLO

Materiale	AISI 304
Finitura	Spazzolato
Raggio interno	Saldato 0 mm
Misure esterne	440 x 440 mm
Misure vasca	400 x 400 mm
Profondità vasca	200 mm
Piletta standard	3 ½"
Base	600 mm

— Sopratop
— Filotop
— Sottotop

Cod. **PR I 40**
Cod. **PR G 40**
Cod. **PR O 40**

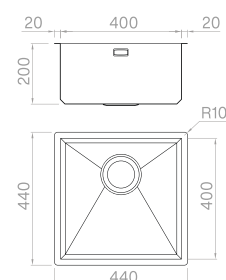

Accessori a pag. 139

PRISMA 34

SOLO

Materiale	AISI 304
Finitura	Spazzolato
Raggio interno	Saldato 0 mm
Misure esterne	380 x 440 mm
Misure vasca	340 x 400 mm
Profondità vasca	200 mm
Piletta standard	3 ½"
Base	450 mm

— Sopratop
— Filotop
— Sottotop

Cod. **PR I 34**
Cod. **PR G 34**
Cod. **PR O 34**

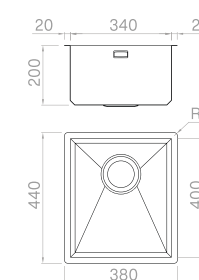

Accessori a pag. 139



Tagliere in legno rovere

3

300x420x20 mm

Cod. **TRIB 3042**

Tagliere in HDPE

6

240x420x20 mm

Cod. **TRP 2442**

Tagliere in PaperStone®

54

300x420x20 mm

Cod. **TRPS 3042**

Griglia

12

250x420x25 mm

Cod. **GRS 2542**

Vaschetta forata

16

210x420x60 mm

Cod. **VQSF 2142**

Vaschetta inclinata forata

23

280x420x110/60 mm

Cod. **VQSI 2842**

Vaschetta

26

280x420x160 mm

Cod. **VQSP 2842**

Set gastronorm

30

240x420x100 mm

Cod. **TI 2442 V**

Set scolapasta

32

240x420x100 mm

Cod. **TI 2442 1S**

Set grattugie

34

200x420x70 mm

Cod. **TI 2442 PG**

Portapiatti

36

250x420x55 mm

Cod. **PPPB V400**

Goggiolatoio

61

340x420x30 mm

Cod. **VQSI 3442**

GHOST

Ghost ha un ribassamento nella parete posteriore che consente l'alloggiamento del miscelatore all'interno dell'area operativa: una soluzione brillante in uno spazio contenuto e di qualità premium.



GHOST 60

READY

Tagliere PaperStone®
Miscelatore Circle

73
45



— Sopratop
— Filotop
— Sottotop

Cod. **SAG I 60 RM**
Cod. **SAGF 60 RM**
Cod. **SAGO 60 RM**

GHOST 60

PRO

Miscelatore Circle

45



— Sopratop
— Filotop
— Sottotop

Cod. **SBG I 60 RM**
Cod. **SBGF 60 RM**
Cod. **SBGO 60 RM**

GHOST 60

SOLO

Materiale	AISI 304
Finitura	Spazzolato
Raggio interno	Saldato 10 mm
Misure esterne	440 x 520 mm
Misure vasca	400 x 400 + 80 mm
Profondità vasca	65/200 mm
Piletta Plus	3 ½"
Base	600 mm



— Sopratop
— Filotop
— Sottotop

Cod. **SIG 60 RM**
Cod. **SFG 60 RM**
Cod. **SSG 60 RM**

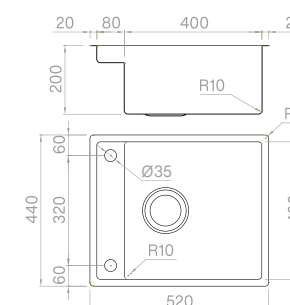

Accessori a pag. 143



Tagliere in legno rovere

3

300x420x20 mm

Cod. **TRIB 3042**

Tagliere in HDPE

6

240x420x20 mm

Cod. **TRP 2442**

Vaschetta forata

16

210x420x60 mm

Cod. **VQSF 2142**

Griglia

12

250x420x25 mm

Cod. **GRS 2542**

Tagliere in PaperStone®

73

200x420x19 mm

Cod. **TRPS 2042**

Set gastronorm

30

240x420x100 mm

Cod. **TI 2442 V**

Set scolapasta

32

240x420x100 mm

Cod. **TI 2442 1S**

Set grattugie

34

200x420x70 mm

Cod. **TI 2442 PG**

Portapiatti

36

250x420x55 mm

Cod. **PPPB V400**

Set gastronorm PaperStone®

76

200x420x20 mm

Cod. **TI 2442 VP**

Set scolapasta PaperStone®

77

200x420x20 mm

Cod. **TI 2442 SP**

Set grattugie PaperStone®

75

200x420x20 mm

Cod. **TI 2442 GP**

MOSE

La collezione Mose è caratterizzata da lavelli a doppia vasca con ponte ribassato, che consente lo scorrimento degli accessori su tutta la lunghezza. In alcuni modelli, l'alloggiamento del miscelatore è integrato nell'area operativa.



MOSE SB 81 READY



Tagliere in legno
Vaschetta forata
Miscelatore Hero

3
16
39

— Sopratop
— Filotop
— Sottotop

Cod. **SAM I 81 R1**
Cod. **SAMG 81 R1**
Cod. **SAMO 81 R1**

MOSE SB 81 PRO



Vaschetta forata

16

— Sopratop
— Filotop
— Sottotop

Cod. **SBM I 81 R1**
Cod. **SBMG 81 R1**
Cod. **SBMO 81 R1**

MOSE SB 81 SOLO



Materiale	AISI 304
Finitura	Spazzolato
Raggio interno	Saldato 10 mm
Misure esterne	810 x 440 mm
Misure vasca	400 x 400 mm / 340 x 400 mm
Profondità vasca	200 mm
Piletta standard	3 ½"
Base	900 mm

— Sopratop
— Filotop
— Sottotop

Cod. **MI 8140 R1**
Cod. **MG 8140 R1**
Cod. **MO 8140 R1**

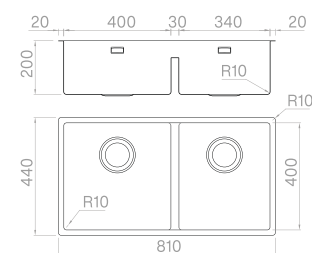

Accessori a pag. 151

MOSE SB 60 READY



Tagliere in legno
Vaschetta forata
Miscelatore Hero

3
16
39

— Sopratop
— Filotop
— Sottotop

Cod. **SAM I 60 R1**
Cod. **SAMG 60 R1**
Cod. **SAMO 60 R1**

MOSE SB 60 PRO



Vaschetta forata

16

— Sopratop
— Filotop
— Sottotop

Cod. **SBM I 60 R1**
Cod. **SBMG 60 R1**
Cod. **SBMO 60 R1**

MOSE SB 60 SOLO



Materiale	AISI 304
Finitura	Spazzolato
Raggio interno	Saldato 10 mm
Misure esterne	590 x 440 mm
Misure vasca	180 x 400 mm / 340 x 400 mm
Profondità vasca	170 / 200 mm
Piletta standard	3 ½"
Base	600 mm

— Sopratop
— Filotop
— Sottotop

Cod. **MI 6040 R1**
Cod. **MG 6040 R1**
Cod. **MO 6040 R1**

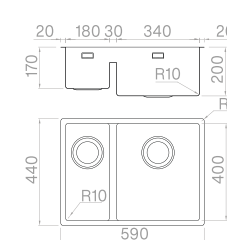

Accessori a pag. 151

MOSE BR 81 READY



Tagliere in legno
Vaschetta forata
Miscelatore Hero

3
16
39

Sopratop
 Filotop

Cod. **SAM BR I 81**Cod. **SAM BRG 81**

MOSE BR 81 PRO



Vaschetta forata

16

Sopratop
 Filotop

Cod. **SBM BR I 81**Cod. **SBM BRG 81**

MOSE BR 81 SOLO



Materiale	AISI 304
Finitura	Spazzolato
Raggio interno	Saldato 10 mm
Misure esterne	810 x 510 mm
Misure vasca	400 x 400 mm / 340 x 400 mm
Profondità vasca	200 mm
Piletta standard	3 ½"
Base	900 mm

Sopratop
 Filotop

Cod. **ALM BR I 81**Cod. **ALM BRG 81**

Foro miscelatore:
specificare fori extra
in fase di ordine.

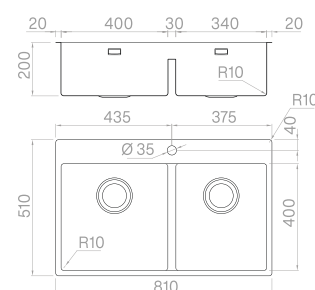

Accessori a pag. 151

MOSE BR 60 READY



Tagliere in legno
Vaschetta forata
Miscelatore Hero

3
16
39

Sopratop
 Filotop

Cod. **SAM BR I 60**Cod. **SAM BRG 60**

MOSE BR 60 PRO



Vaschetta forata

16

Sopratop
 Filotop

Cod. **SBM BR I 60**Cod. **SBM BRG 60**

MOSE BR 60 SOLO



Materiale	AISI 304
Finitura	Spazzolato
Raggio interno	Saldato 10 mm
Misure esterne	590 x 510 mm
Misure vasca	180 x 400 mm / 340 x 400 mm
Profondità vasca	170 / 200 mm
Piletta standard	3 ½"
Base	600 mm

Sopratop
 Filotop

Cod. **ALM BR I 60**Cod. **ALM BRG 60**

Foro miscelatore:
specificare fori extra
in fase di ordine.

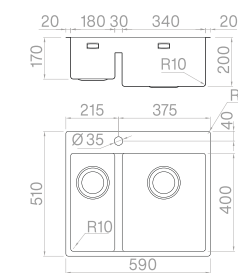

Accessori a pag. 151

Tagliere in legno rovere

3

300x420x20 mm
Cod. **TRIB 3042**

Tagliere in HDPE

6

240x420x20 mm
Cod. **TRP 2442**

Tagliere PaperStone®

73

200x420x19 mm
Cod. **TRPS 2042**

Tagliere in PaperStone®

54

300x420x20 mm
Cod. **TRPS 3042**

Griglia

12

250x420x25 mm
Cod. **GRS 2542**

Vaschetta forata

16

210x420x60 mm
Cod. **VQSF 2142**

Portapiatti

36

250x420x55 mm
Cod. **PPPB V400**

Goggiolatoio

61

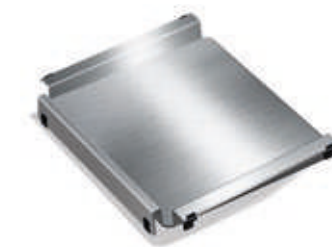
340x420x30 mm
Cod. **VQSI 3442**

Set gastronorm PaperStone®

76

200x420x20 mm
Cod. **TI 2442 VP**

Set scolapasta PaperStone®

77

200x420x20 mm
Cod. **TI 2442 SP**

Set grattugie PaperStone®

75

200x420x20 mm
Cod. **TI 2442 GP**

NEWGO



NEWGO MATTE VINTAGE

Una workstation elegante e sofisticata grazie all'abbinamento fra l'acciaio Matte Vintage e la finitura nera dei miscelatori e degli accessori.



NEWGO 81 MATTE VINTAGE

READY



Griglia matte vintage **13**
 Vaschetta inclinata forata matte vintage **24**
 Miscelatore Ergo **41**



Soprato

Filoto

Cod. **SAG I 81H**

Cod. **SAGG 81H**

NEWGO 81 MATTE VINTAGE

PRO



Griglia matte vintage **13**



Soprato

Filoto

Cod. **SBG I 81H**

Cod. **SBGG 81H**

NEWGO 81 MATTE VINTAGE

SOLO



Materiale	AISI 304
Finitura	Spazzolato opaco
Raggio interno	Saldato 10 mm
Misure esterne	850 x 530 mm
Misure vasca	810 x 400 mm
Profondità vasca	220 mm
Piletta automatica nera	3 1/2"
Base	900 mm



Soprato

Filoto

Cod. **ALG I 81H**

Cod. **ALGG 81H**

Foro miscelatore:
 specificare fori extra
 in fase di ordine.

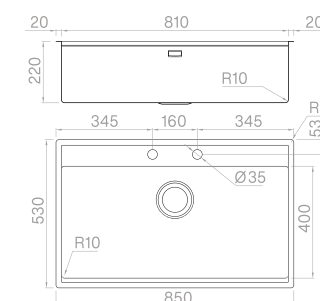

Accessori a pag. 157

NEWGO 70 MATTE VINTAGE

READY



Griglia matte vintage

13

Vaschetta inclinata forata matte vintage

24

Miscelatore Ergo

41



Soprato

Cod. **SAG I 70H**

Filotop

Cod. **SAGG 70H**

NEWGO 70 MATTE VINTAGE

PRO



Griglia matte vintage

13



Soprato

Cod. **SBG I 70H**

Filotop

Cod. **SBGG 70H**

NEWGO 70 MATTE VINTAGE

SOLO



Materiale

AISI 304

Finitura

Spazzolato opaco

Raggio interno

Saldato 10 mm

Misure esterne

740 x 530 mm

Misure vasca

700 x 400 mm

Profondità vasca

220 mm

Piletta automatica nera

3 ½"

Base

800 mm



Soprato

Cod. **ALG I 70H**

Filotop

Cod. **ALGG 70H**

Foro miscelatore:
specificare fori extra
in fase di ordine.

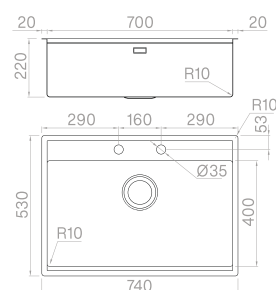

Accessori a pag. 157

Tagliere in legno rovere

3

300x420x20 mm

Cod. **TRIB 3042**

Tagliere in HDPE

6

240x420x20 mm

Cod. **TRP 2442**

Tagliere in PaperStone®

54

300x420x20 mm

Cod. **TRPS 3042**

Griglia matte vintage

13

250x420x25 mm

Cod. **GRH 2542**

Vaschetta inclinata forata matte vintage

24

280x420x110/60 mm

Cod. **VQHI 2842**

Set gastronorm PaperStone®

76

200x420x20 mm

Cod. **TI 2442 VP**

Set scolapasta PaperStone®

77

200x420x20 mm

Cod. **TI 2442 SP**

Set grattugie PaperStone®

75

200x420x20 mm

Cod. **TI 2442 GP**

Porta piatti

36

250x420x55 mm

Cod. **PPPB V400**

NEWGO

La profondità maggiorata e il ribassamento perimetrale consentono l'alloggiamento del miscelatore all'interno dell'area di lavoro.



NEWGO 81

READY



Griglia **12**
 Vaschetta inclinata forata **23**
 Miscelatore Circle **45**



Cod. **SAG I 81**

Cod. **SAGG 81**

NEWGO 81

PRO



Griglia **12**



Cod. **SBG I 81**

Cod. **SBGG 81**

NEWGO 81

SOLO



Materiale	AISI 304
Finitura	Spazzolato
Raggio interno	Saldato 10 mm
Misure esterne	850 x 530 mm
Misure vasca	810 x 400 mm
Profondità vasca	220 mm
Piletta automatica Plus	3 1/2"
Base	900 mm



Cod. **ALG I 81**

Cod. **ALGG 81**

Foro miscelatore:
 specificare fori extra
 in fase di ordine.

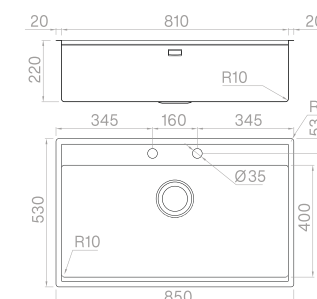

Accessori a pag. 161

NEWGO 70

READY



Griglia
Vaschetta inclinata forata
Miscelatore Circle

12
23
45



Cod. **SAG I 70**
Cod. **SAGG 70**

NEWGO 70

PRO



Supporto grigliato

12



Cod. **SBG I 70**
Cod. **SBGG 70**

NEWGO 70

SOLO



Materiale	AISI 304
Finitura	Spazzolato
Raggio interno	Saldato 10 mm
Misure esterne	740 x 530 mm
Misure vasca	700 x 400 mm
Profondità vasca	220 mm
Piletta automatica Plus	3 ½"
Base	800 mm



Cod. **ALG I 70**
Cod. **ALGG 70**

Accessori a pag. 161

Foro miscelatore:
specificare fori extra
in fase di ordine.

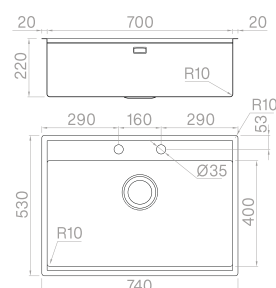

Tagliere in legno rovere

3

300x420x20 mm
Cod. **TRIB 3042**



Tagliere in HDPE

6

240x420x20 mm
Cod. **TRP 2442**



Griglia

12

250x420x25 mm
Cod. **GRS 2542**



Set vaschetta forata

16

210x420x60 mm
Cod. **VQSF 2142**



Vaschetta forata inclinata

23

280x420x110/60 mm
Cod. **VQSI 2842**



Vaschetta

26

280x420x160 mm
Cod. **VQSP 2842**



Set gastronorm PaperStone®

76

200x420x20 mm
Cod. **TI 2442 VP**



Set scolapasta PaperStone®

77

200x420x20 mm
Cod. **TI 2442 SP**



Set grattugie PaperStone®

75

200x420x20 mm
Cod. **TI 2442 GP**



Porta piatti

36

250x420x55 mm
Cod. **PPPB V400**



Tagliere in PaperStone®

54

300x420x20 mm
Cod. **TRPS 3042**



Goggiolatoio

61

340x420x30 mm
Cod. **VQSI 3442**



AQUA

Aqua è un modello caratterizzato dalla grande capienza e dal design essenziale con gli angoli interni, sempre raggiati di 10 mm e l'alloggiamento del miscelatore integrato nell'area di lavoro.



AQUA 81 READY



Tagliere in legno
Vaschetta forata
Miscelatore Hero

3
16
39

Sopratop
Filotop

Cod. **SAA I 81**
Cod. **SAAG 81**

AQUA 70 READY



Tagliere in legno
Vaschetta forata
Miscelatore Hero

3
16
39

Sopratop
Filotop

Cod. **SAA I 70**
Cod. **SAAG 70**

AQUA 81 PRO



Vaschetta forata

16

Sopratop
Filotop

Cod. **SBA I 81**
Cod. **SBAG 81**

AQUA 70 PRO



Vaschetta forata

16

Sopratop
Filotop

Cod. **SBA I 70**
Cod. **SBAG 70**

AQUA 81 SOLO



Materiale	AISI 304
Finitura	Spazzolato
Raggio interno	Saldato 10 mm
Misure esterne	850 x 510 mm
Misure vasca	810 x 400 mm
Profondità vasca	200 mm
Piletta standard	3 ½"
Base	900 mm

Sopratop
Filotop

Cod. **ALA I 81**
Cod. **ALAG 81**

AQUA 70 SOLO



Materiale	AISI 304
Finitura	Spazzolato
Raggio interno	Saldato 10 mm
Misure esterne	740 x 510 mm
Misure vasca	700 x 400 mm
Profondità vasca	200 mm
Piletta standard	3 ½"
Base	800 mm

Sopratop
Filotop

Cod. **ALA I 70**
Cod. **ALAG 70**

Foro miscelatore:
specificare fori extra
in fase di ordine.

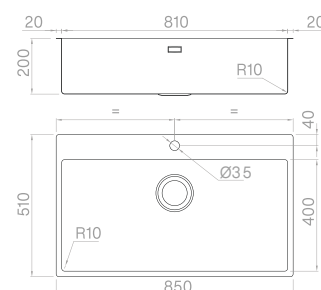

Accessori a pag. 169

Foro miscelatore:
specificare fori extra
in fase di ordine.

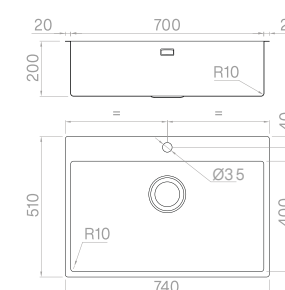

Accessori a pag. 169

AQUA 65 READY



Tagliere in legno
Vaschetta forata
Miscelatore Hero

3
16
39

Sopratop
 Filotop

Cod. **SAA I 65**
Cod. **SAAG 65**

AQUA 50 READY



Tagliere in legno
Vaschetta forata
Miscelatore Hero

3
16
39

Sopratop
 Filotop

Cod. **SAA I 50**
Cod. **SAAG 50**

AQUA 65 PRO



Vaschetta forata

16

Sopratop
 Filotop

Cod. **SBA I 65**
Cod. **SBAG 65**

AQUA 50 PRO



Vaschetta forata

16

Sopratop
 Filotop

Cod. **SBA I 50**
Cod. **SBAG 50**

AQUA 65 SOLO



Materiale	AISI 304
Finitura	Spazzolato
Raggio interno	Saldato 10 mm
Misure esterne	690 x 510 mm
Misure vasca	650 x 400 mm
Profondità vasca	200 mm
Piletta standard	3 ½"
Base	750 mm

Sopratop
 Filotop

Cod. **ALA I 65**
Cod. **ALAG 65**

AQUA 50 SOLO



Materiale	AISI 304
Finitura	Spazzolato
Raggio interno	Saldato 10 mm
Misure esterne	540 x 510 mm
Misure vasca	500 x 400 mm
Profondità vasca	200 mm
Piletta standard	3 ½"
Base	600 mm

Sopratop
 Filotop

Cod. **ALA I 50**
Cod. **ALAG 50**

Foro miscelatore:
specificare fori extra
in fase di ordine.

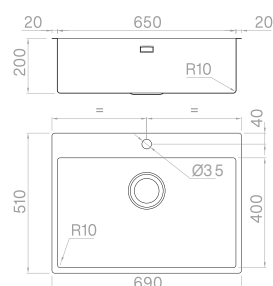

Accessori a pag. 169

Foro miscelatore:
specificare fori extra
in fase di ordine.

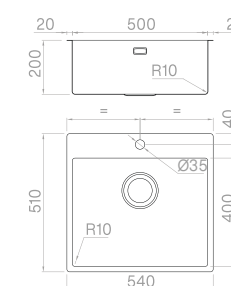

Accessori a pag. 169

Tagliere in legno rovere
3

300x420x20 mm

 Cod. **TRIB 3042**

Tagliere in HDPE
6

240x420x20 mm

 Cod. **TRP 2442**

Tagliere in PaperStone®
54

300x420x20 mm

 Cod. **TRPS 3042**

Griglia
12

250x420x25 mm

 Cod. **GRS 2542**

Vaschetta forata
16

210x420x60 mm

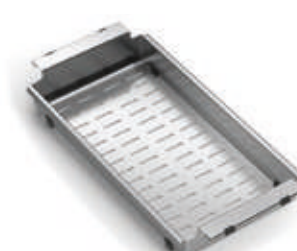
 Cod. **VQSF 2142**

Vaschetta inclinata forata
23

280x420x110/60 mm

 Cod. **VQSI 2842**

Vaschetta
26

280x420x160 mm

 Cod. **VQSP 2842**

Set gastronorm
30

240x420x100 mm

 Cod. **TI 2442 V**

Set scolapasta
32

240x420x100 mm

 Cod. **TI 2442 1S**

Set grattugie
34

200x420x70 mm

 Cod. **TI 2442 PG**

Portapiatti
36

250x420x55 mm

 Cod. **PPPB V400**

Goggiolatoio
61

340x420x30 mm

 Cod. **VQSI 3442**





OUTDOOR

STARTAC MARINA

La cucina conquista nuovi spazi all'aperto. Realizzato in acciaio marino AISI 316 L, Startac è progettato per offrire la medesima funzionalità ed igiene in ambienti esterni. Incluso di copertina, in posizione chiusa, Startac si integra nel piano con eleganza e discrezione.



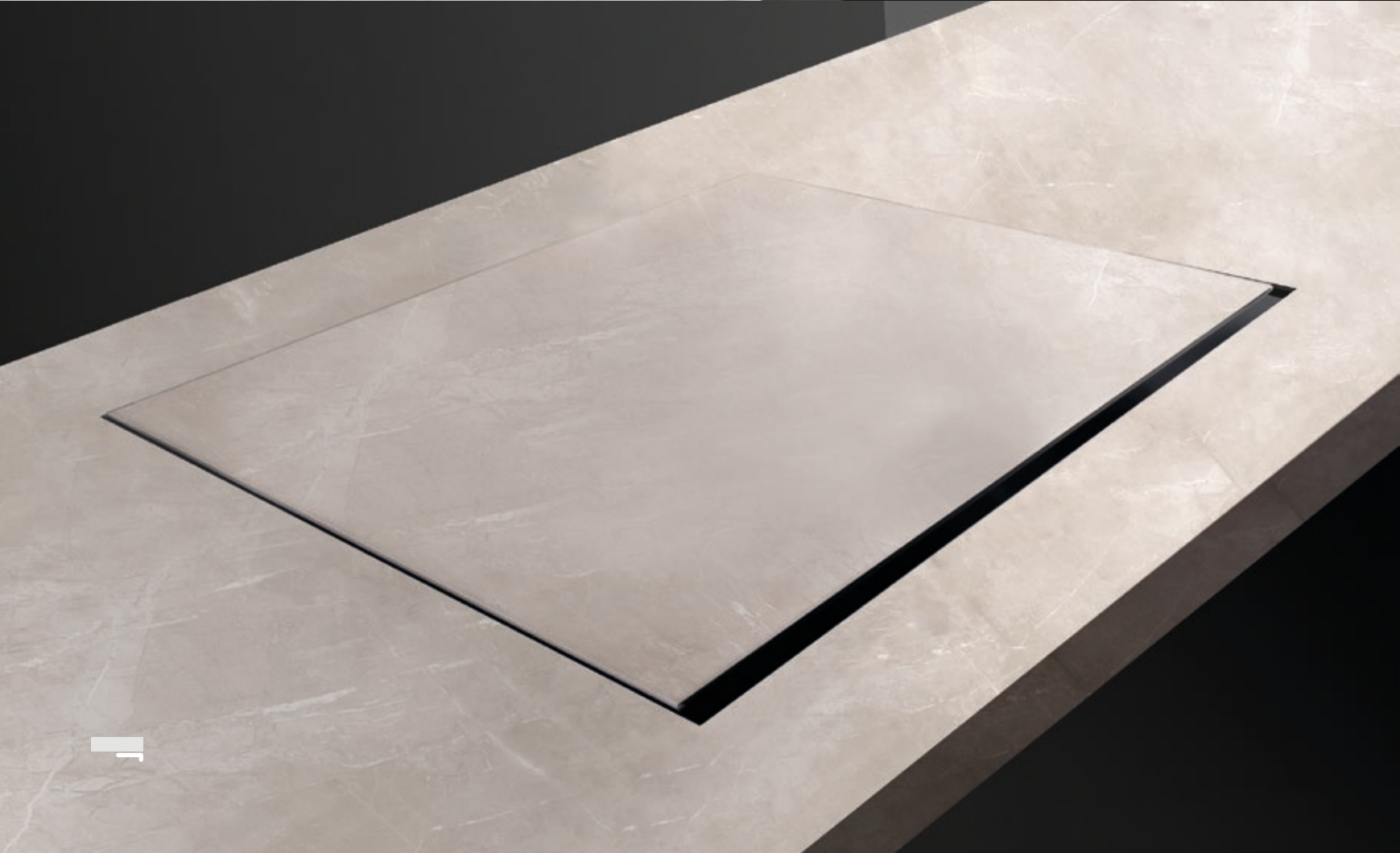



STARTAC MARINA 55

READY



Vaschetta forata
Miscelatore Circle Steel

58
52

 Sopratop

Cod. **SAMC 55**

STARTAC MARINA 55

PRO



Miscelatore Circle Steel

52

 Sopratop

Cod. **SBMC 55**

STARTAC MARINA 55

SOLO



Materiale	AISI 316 L
Finitura	Spazzolato
Raggio interno	Saldato 10 mm
Misure esterne	590 x 510 mm
Misure vasca	550 x 350 mm
Profondità vasca	240 mm
Piletta Plus	3 1/2"
Base	600 mm

 Sopratop
 Sottotop

Cod. **MC 55**
Cod. **MC 55G**

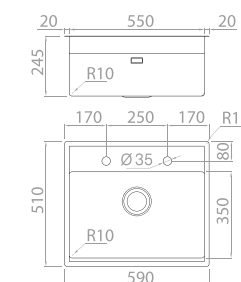

Accessori a pag. 186

GHOST MARINA

Realizzata in AISI 316 L, questa brillante soluzione diventa l'ideale quando gli spazi sono contenuti. La zona ribassata permette di alloggiare il miscelatore all'interno dell'area operativa.



GHOST MARINA 60

READY

Tagliere PaperStone®
Miscelatore Circle Steel

73

52



 Sopratop
 Sottotop

Cod. **SAGO 60 MG**

Cod. **SAGS 60 MG**

GHOST MARINA 60

PRO

Miscelatore Circle Steel

52



 Sopratop
 Sottotop

Cod. **SBGO 60 MG**

Cod. **SBGS 60 MG**

GHOST MARINA 60

SOLO

Materiale	AISI 316 L
Finitura	Spazzolato
Raggio interno	Saldato 10 mm
Misure esterne	440 x 520 mm
Misure vasca	400 x 400 + 80 mm
Profondità vasca	65 / 200 mm
Piletta Plus	3 1/2"
Base	600 mm



 Sopratop
 Sottotop

Cod. **SIG 60 MG**

Cod. **SSG 60 MG**

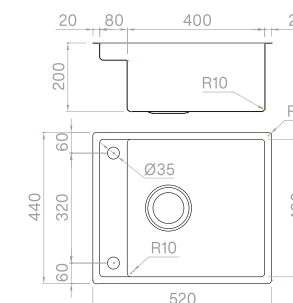

Accessori a pag. 186

RADIUS MARINA



La gamma è caratterizzata dalla composizione chimica di AISI 316 L. Questa lega di acciaio inossidabile è più resistente alla corrosione e all'ossidazione e quindi è più adatta a resistere all'esterno, specialmente in ambienti marini.



RADIUS MARINA 70 READY





Tagliere PaperStone® **54**
 Vaschetta inclinata forata **51**
 Miscelatore Circle Steel **52**

 Sopratop Cod. **SABI 70 MR**
 Filotop Cod. **SABG 70 MR**
 Sottotop Cod. **SABO 70 MR**

RADIUS MARINA 70 PRO





Vaschetta forata **50**

 Sopratop Cod. **SBBI 70 MR**
 Filotop Cod. **SBBG 70 MR**
 Sottotop Cod. **SBBO 70 MR**

RADIUS MARINA 70 SOLO



Materiale	AISI 316 L
Finitura	Spazzolato
Raggio interno	Saldato 10 mm
Misure esterne	740 x 530 mm
Misure vasca	700 x 400 mm
Profondità vasca	220 mm
Piletta standard	3 1/2"
Base	800 mm

 Sopratop Cod. **BI 7040 MR**
 Filotop Cod. **BG 7040 MR**
 Sottotop Cod. **BO 7040 MR**

Accessori a pag. 186

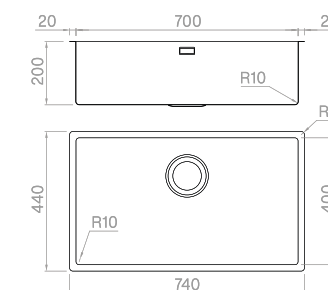

RADIUS MARINA 50

READY



Tagliere PaperStone®
Vaschetta inclinata forata
Miscelatore Circle Steel

54
51
52

— Sopratop
— Filotop
— Sottotop

Cod. **SABI 50 MR**
Cod. **SABG 50 MR**
Cod. **SABO 50 MR**

RADIUS MARINA 50

PRO



Vaschetta forata

50

— Sopratop
— Filotop
— Sottotop

Cod. **SBBI 50 MR**
Cod. **SBBG 50 MR**
Cod. **SBBO 50 MR**

RADIUS MARINA 50

SOLO



Materiale	AISI 316 L
Finitura	Spazzolato
Raggio interno	Saldato 10 mm
Misure esterne	540 x 440 mm
Misure vasca	500 x 400 mm
Profondità vasca	200 mm
Piletta standard	3 ½"
Base	600 mm

— Sopratop
— Filotop
— Sottotop

Cod. **BI 5040 MR**
Cod. **BG 5040 MR**
Cod. **BO 5040 MR**

Accessori a pag. 186

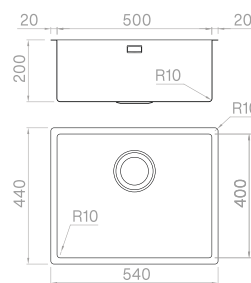

RADIUS MARINA 45

READY



Tagliere PaperStone®
Vaschetta forata
Miscelatore Circle Steel

54
50
52

— Sopratop
— Filotop
— Sottotop

Cod. **SABI 45 MR**
Cod. **SABG 45 MR**
Cod. **SABO 45 MR**

RADIUS MARINA 45

PRO



Vaschetta forata

50

— Sopratop
— Filotop
— Sottotop

Cod. **SBBI 45 MR**
Cod. **SBBG 45 MR**
Cod. **SBBO 45 MR**

RADIUS MARINA 45

SOLO



Materiale	AISI 316 L
Finitura	Spazzolato
Raggio interno	Saldato 10 mm
Misure esterne	490 x 440 mm
Misure vasca	450 x 400 mm
Profondità vasca	200 mm
Piletta standard	3 ½"
Base	600 mm

— Sopratop
— Filotop
— Sottotop

Cod. **BI 4540 MR**
Cod. **BG 4540 MR**
Cod. **BO 4540 MR**

Accessori a pag. 186

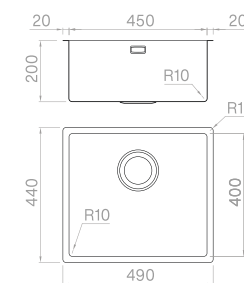

RADIUS MARINA 40

READY



Tagliere PaperStone®
Vaschetta forata
Miscelatore Circle Steel

54
50
52

— Sopratop
— Filotop
— Sottotop

Cod. **SABI 40 MR**
Cod. **SABG 40 MR**
Cod. **SABO 40 MR**

RADIUS MARINA 40

PRO



Vaschetta forata

50

— Sopratop
— Filotop
— Sottotop

Cod. **SBBI 40 MR**
Cod. **SBBG 40 MR**
Cod. **SBBO 40 MR**

RADIUS MARINA 40

SOLO



Materiale	AISI 316 L
Finitura	Spazzolato
Raggio interno	Saldato 10 mm
Misure esterne	440 x 440 mm
Misure vasca	400 x 400 mm
Profondità vasca	200 mm
Piletta standard	3 ½"
Base	600 mm

— Sopratop
— Filotop
— Sottotop

Cod. **BI 4040 MR**
Cod. **BG 4040 MR**
Cod. **BO 4040 MR**

Accessori a pag. 186

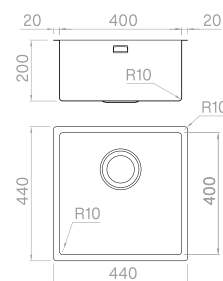

RADIUS MARINA 34

READY



Tagliere PaperStone®
Vaschetta forata
Miscelatore Circle Steel

54
50
52

— Sopratop
— Filotop
— Sottotop

Cod. **SABI 34 MR**
Cod. **SABG 34 MR**
Cod. **SABO 34 MR**

RADIUS MARINA 34

PRO



Vaschetta forata

50

— Sopratop
— Filotop
— Sottotop

Cod. **SBBI 34 MR**
Cod. **SBBG 34 MR**
Cod. **SBBO 34 MR**

RADIUS MARINA 34

SOLO



Materiale	AISI 316 L
Finitura	Spazzolato
Raggio interno	Saldato 10 mm
Misure esterne	380 x 440 mm
Misure vasca	340 x 400 mm
Profondità vasca	200 mm
Piletta standard	3 ½"
Base	450 mm

— Sopratop
— Filotop
— Sottotop

Cod. **BI 3440 MR**
Cod. **BG 3440 MR**
Cod. **BO 3440 MR**

Accessori a pag. 186

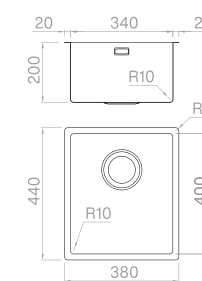

RADIUS MARINA 18

SOLO

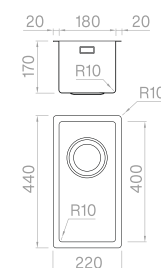

Materiale	AISI 316 L
Finitura	Spazzolato
Raggio interno	Saldato 10 mm
Misure esterne	220 x 440 mm
Misure vasca	180 x 400 mm
Profondità vasca	170 mm
Piletta standard	3 1/2"
Base	300 mm

-  Sopratop
-  Filotop
-  Sottotop

- Cod. **BI 1840 MR**
- Cod. **BG 1840 MR**
- Cod. **BO 1840 MR**

ACCESSORI DEDICATI

Tagliere PaperStone®

54

300x420x20 mm
Cod. **TRPS 3042**



Tagliere PaperStone®

73

200x420x19 mm
Cod. **TRPS 2042**



Set grattugie PaperStone®

75

200x420x20 mm
Cod. **TI 2442 GP**



Vaschetta forata

50

210x420x60 mm
Cod. **VQMF 2142**



Vaschetta inclinata forata

51

280x420x110/60 mm
Cod. **VQMI 2842**



Vaschetta forata

58

210x375x60 mm
Cod. **VQMF 2137**





CANALI
ATTREZZATI

CANALI ATTREZZATI

Sviluppati per contenere una gamma di elementi intercambiabili, i canali attrezzati sono perfetti per ottimizzare lo spazio e migliorare la funzionalità dell'area di preparazione in cucina. Disponibile in diverse lunghezze, questo sistema modulare è offerto in ben tre diverse opzioni di installazione al piano di preparazione.



LE INSTALLAZIONI

Ontop

Il canale attrezzato sporge dal piano di 40 mm, risaltando come forma geometrica pura.



MODULARITÀ 12, 10, 8, 6, 5 E 4 UNIT

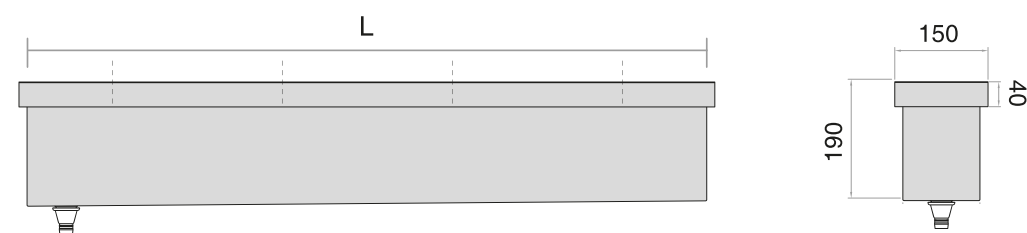

Sopratop

Il sopratop permette sempre la facile installazione su ogni tipologia di piano cucina.

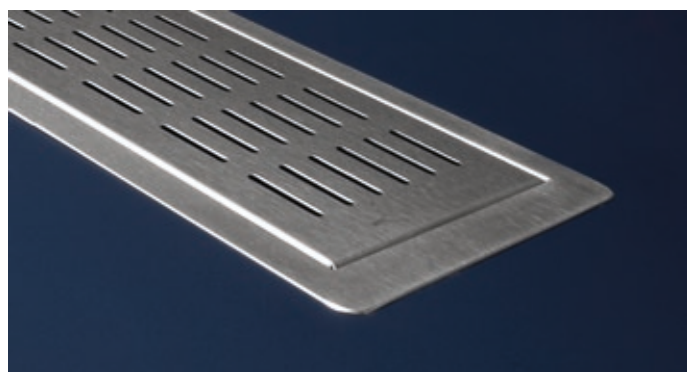

MODULARITÀ 12, 10, 8, 6, 5 E 4 UNIT

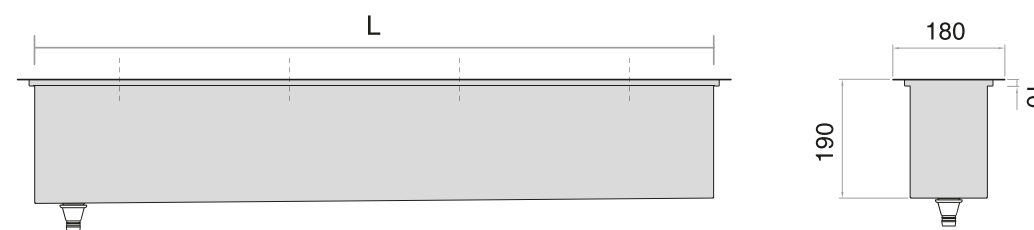

Sottotop

Questa installazione nascosta permette agli accessori di allinearsi alla superficie del piano.



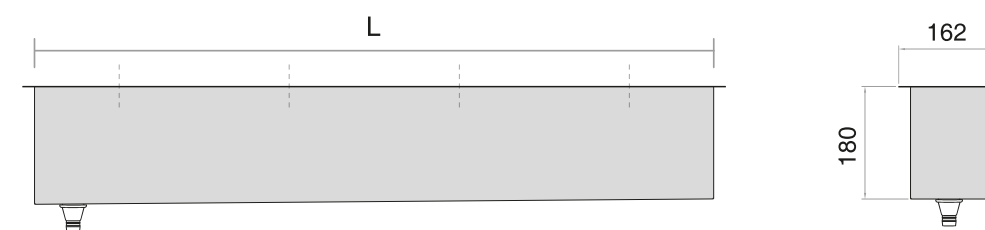

MODULARITÀ 12, 10, 8, 6, 5 E 4 UNIT



CANALE ATTREZZATO 180





Materiale	AISI 304
Finitura	Spazzolato
Misure interne	1635 x 140 mm
Profondità	190 mm
Piletta	Kit scarico incluso
Base	1800 mm
Modularità	12 unità

 Ontop	Cod. CAI 18
 Sopratop	Cod. CAG 18
 Sottotop	Cod. CAO 180

CANALE ATTREZZATO 150





Materiale	AISI 304
Finitura	Spazzolato
Misure interne	1363 x 140 mm
Profondità	190 mm
Piletta	Kit scarico incluso
Base	1500 mm
Modularità	10 unità

 Ontop	Cod. CAI 15
 Sopratop	Cod. CAG 15
 Sottotop	Cod. CAO 150

CANALE ATTREZZATO 120





Materiale	AISI 304
Finitura	Spazzolato
Misure interne	1090 x 140 mm
Profondità	190 mm
Piletta	Kit scarico incluso
Base	1200 mm
Modularità	8 unità

 Ontop	Cod. CAI 12
 Sopratop	Cod. CAG 12
 Sottotop	Cod. CAO 120

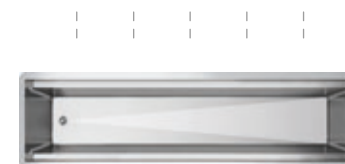
CANALE ATTREZZATO 90





Materiale	AISI 304
Finitura	Spazzolato
Misure interne	818 x 140 mm
Profondità	190 mm
Piletta	Kit scarico incluso
Base	900 mm
Modularità	6 unità

 Ontop	Cod. CAI 90
 Sopratop	Cod. CAG 90
 Sottotop	Cod. CAO 90

CANALE ATTREZZATO 75





Materiale	AISI 304
Finitura	Spazzolato
Misure interne	682 x 140 mm
Profondità	190 mm
Piletta	Kit scarico incluso
Base	750 mm
Modularità	5 unità

 Ontop	Cod. CAI 75
 Sopratop	Cod. CAG 75
 Sottotop	Cod. CAO 75

CANALE ATTREZZATO 60



Materiale	AISI 304
Finitura	Spazzolato
Misure interne	546 x 140 mm
Profondità	190 mm
Piletta	Kit scarico incluso
Base	600 mm
Modularità	4 unità

 Ontop	Cod. CAI 60
 Sopratop	Cod. CAG 60
 Sottotop	Cod. CAO 60

Porta utensili

136x140 mm

Unità: 1

Cod. **PU 13 B**

Ripiano forato piccolo

136x140 mm

Unità: 1

Cod. **RPF 13 B**

Ripiano forato + supporto device

136x140 mm

Unità: 1

Cod. **RFSD 13 B**

Caricabatteria wireless

136x140 mm

Unità: 1

Cod. **CW 13 B**

Cassa bluetooth

136x140 mm

Unità: 1

Cod. **CABL 13 B**

Presa USB + Type C

136x140 mm

Unità: 1

Cod. **PUSB 13 B**

Porta miscelatore piccolo

136x140 mm

Unità: 1

Cod. **PM 13 B**

Porta miscelatore 1F

272x140 mm

Unità: 2

Cod. **PM 1 FB**

Porta miscelatore 2F

272x140 mm

Unità: 2

Cod. **PM 2 FB**

Porta miscelatore 3F

272x140 mm

Unità: 2

Cod. **PM 3 FB**

Ripiano forato grande

272x140 mm

Unità: 2

Cod. **RFG 27 B**

Vaschetta

272x140 mm

Unità: 2

Cod. **VASF 27 B**

Vaschetta + porta piatti

272x140 mm

Unità: 2

Cod. **VPP 27 B**

Presca elettrica a scomparsa

272x140 mm

Unità: 2

Cod. **PESVPB**

Vaschetta porta piante

272x140 mm

Unità: 2

Cod. **VPP 2 HB**

Vaschetta porta piante

408x140 mm

Unità: 3

Cod. **VPP 3 HB**

Vaschetta

408x140 mm

Unità: 3

Cod. **VASF 40 B**

Vaschetta + porta coltelli legno rovere

408x140 mm

Unità: 3

Cod. **VPCLR 40 B**

Vaschetta + porta coltelli legno acacia

408x140 mm

Unità: 3

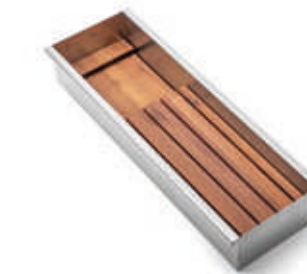
Cod. **VPCL 40 B**

CANALE ATTREZZATO 180

Materiale	AISI 304
Finitura	Spazzolato opaco
Misure interne	1635 x 140 mm
Profondità	190 mm
Piletta	Kit scarico incluso
Base	1800 mm
Modularità	12 unità



 Sopratop	Cod. CAG 18 MV
 Sottotop	Cod. CAO 180

CANALE ATTREZZATO 150

Materiale	AISI 304
Finitura	Spazzolato opaco
Misure interne	1363 x 140 mm
Profondità	190 mm
Piletta	Kit scarico incluso
Base	1500 mm
Modularità	10 unità



 Sopratop	Cod. CAG 15 MV
 Sottotop	Cod. CAO 150

CANALE ATTREZZATO 120

Materiale	AISI 304
Finitura	Spazzolato opaco
Misure interne	1090 x 140 mm
Profondità	190 mm
Piletta	Kit scarico incluso
Base	1200 mm
Modularità	8 unità



 Sopratop	Cod. CAG 12 MV
 Sottotop	Cod. CAO 120

CANALE ATTREZZATO 90

Materiale	AISI 304
Finitura	Spazzolato opaco
Misure interne	818 x 140 mm
Profondità	190 mm
Piletta	Kit scarico incluso
Base	900 mm
Modularità	6 unità



 Sopratop	Cod. CAG 90 MV
 Sottotop	Cod. CAO 90

CANALE ATTREZZATO 75

Materiale	AISI 304
Finitura	Spazzolato opaco
Misure interne	682 x 140 mm
Profondità	190 mm
Piletta	Kit scarico incluso
Base	750 mm
Modularità	5 unità



 Sopratop	Cod. CAG 75 MV
 Sottotop	Cod. CAO 75

CANALE ATTREZZATO 60

Materiale	AISI 304
Finitura	Spazzolato opaco
Misure interne	546 x 140 mm
Profondità	190 mm
Piletta	Kit scarico incluso
Base	600 mm
Modularità	4 unità



 Sopratop	Cod. CAG 60 MV
 Sottotop	Cod. CAO 60

Porta utensili

136x140 mm

Unità: 1

Cod. **PU 13 MV**

Ripiano forato piccolo

136x140 mm

Unità: 1

Cod. **RPF 13 MV**

Ripiano forato + supporto device

136x140 mm

Unità: 1

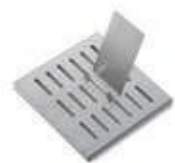
Cod. **RFS 13 MV**

Vaschetta + porta piatti

272x140 mm

Unità: 2

Cod. **VPP 27 MV**

Presca elettrica a scomparsa

272x140 mm

Unità: 2

Cod. **PESVP MV**

Vaschetta porta piante

272x140 mm

Unità: 2

Cod. **VPP 2H MV**

Caricabatteria wireless

136x140 mm

Unità: 1

Cod. **CW 13 MV**

Cassa bluetooth

136x140 mm

Unità: 1

Cod. **CABL 13 MV**

Presca USB + Type C

136x140 mm

Unità: 1

Cod. **PUSB 13 MV**

Vaschetta porta piante

408x140 mm

Unità: 3

Cod. **VPP 3H MV**

Vaschetta

408x140 mm

Unità: 3

Cod. **VASF 40 MV**

Vaschetta + porta coltelli legno rovere

408x140 mm

Unità: 3

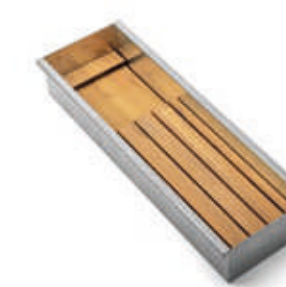
Cod. **VPCLR 40 M**

Porta miscelatore piccolo

136x140 mm

Unità: 1

Cod. **PM 13 MV**

Porta miscelatore 1F

272x140 mm

Unità: 2

Cod. **PM 1F MV**

Porta miscelatore 2F

272x140 mm

Unità: 2

Cod. **PM 2F MV**

Vaschetta + porta coltelli legno acacia

408x140 mm

Unità: 3

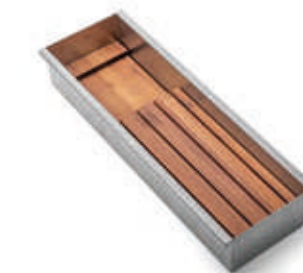
Cod. **VPCL 40 MV**

Porta miscelatore 3F

272x140 mm

Unità: 2

Cod. **PM 3F MV**

Ripiano forato grande

272x140 mm

Unità: 2

Cod. **RFG 27 MV**

Vaschetta

272x140 mm

Unità: 2

Cod. **VASF 27 MV**



MISCELATORI

LOFT



38

Materiale	Acciaio inox AISI 304
Finitura	Spazzolato
Rotazione canna	180°
Foro installazione	Ø 35 mm
Cartuccia	disco ceramico
Doccetta	estraibile

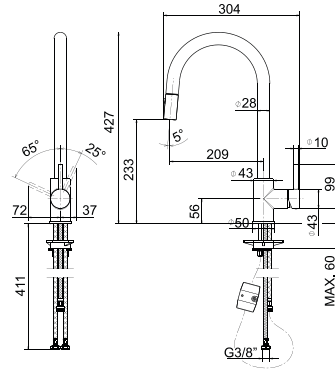
Cod. **SS 02726**

HERO



39

Finitura	Inox spazzolato
Rotazione canna	360°
Foro installazione	Ø 35 mm
Cartuccia	disco ceramico
Doccetta	flessibile con magnete

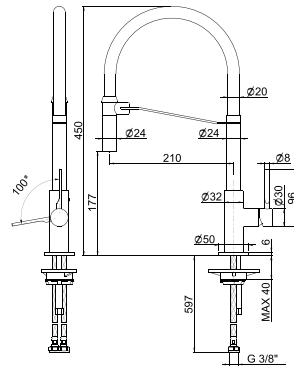
Cod. **SS 02724**

ELEMENT



40

Finitura	Inox spazzolato
Rotazione canna	360°
Foro installazione	Ø 35 mm
Cartuccia	disco ceramico
Doccetta	estraibile

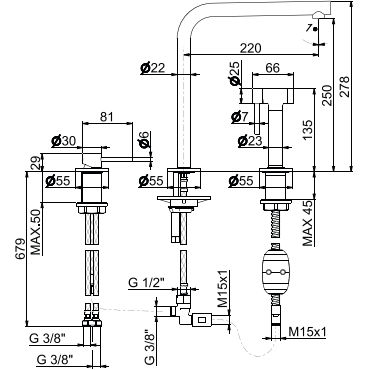
Cod. **SS 02725**

ERGO MATTE BLACK



41

Finitura	Nero opaco
Rotazione canna	360°
Foro installazione	Ø 35 mm
Cartuccia	disco ceramico
Doccetta	estraibile

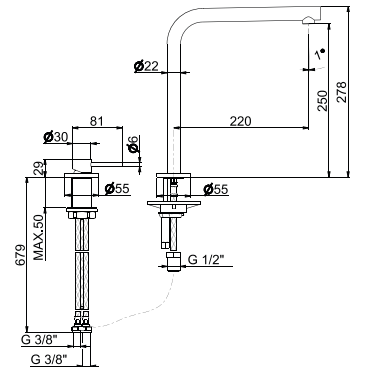
Cod. **SS 02727**

ATHOM GUN METAL

42

Finitura	PVD Gun Metal
Rotazione canna	180°
Foro installazione	Ø 35 mm
Cartuccia	disco ceramico
Doccetta	estraibile

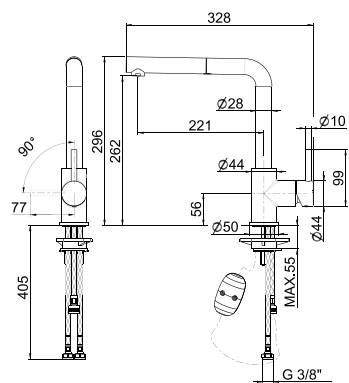
Cod. **SS 02721**

ATHOM COPPER BRONZE

43

Finitura	PVD Copper Bronze
Rotazione canna	180°
Foro installazione	Ø 35 mm
Cartuccia	disco ceramico
Doccetta	estraibile

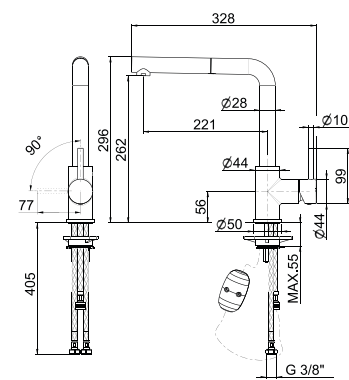
Cod. **SS 02722**

ATHOM PALE GOLD

44

Finitura	PVD Pale Gold
Rotazione canna	180°
Foro installazione	Ø 35 mm
Cartuccia	disco ceramico
Doccetta	estraibile

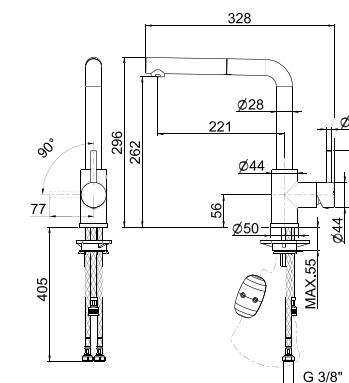
Cod. **SS 02723**

CIRCLE

45

Finitura	Inox spazzolato
Rotazione canna	360°
Foro installazione	Ø 35 mm
Cartuccia	disco ceramico
Doccetta	estraibile

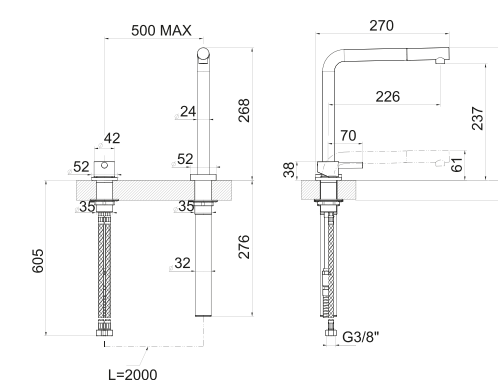
Cod. **SS 02700**

UBER



46

Materiale	Acciaio inox AISI 304
Finitura	Spazzolato
Rotazione canna	360°
Foro installazione	Ø 35 mm
Cartuccia	disco ceramico

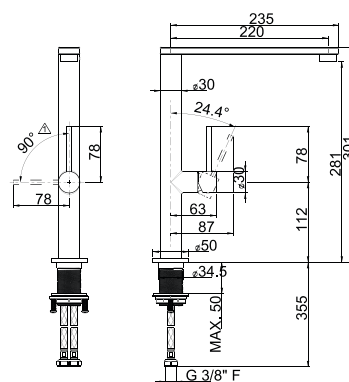
Cod. **SS 02720**

VERTIGO



47

Finitura	Inox spazzolato
Rotazione canna	360°
Foro installazione	Ø 35 mm
Cartuccia	disco ceramico

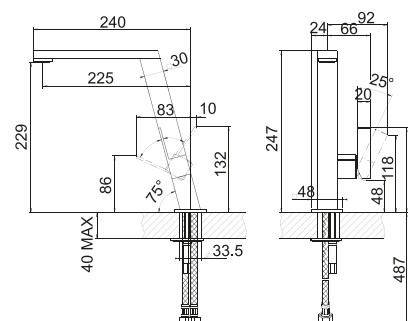
Cod. **SS 01164**

CIRCLE STEEL



52

Materiale	Acciaio inox AISI 316 L
Finitura	Spazzolato
Rotazione canna	360°
Foro installazione	Ø 35 mm
Cartuccia	disco ceramico
Doccetta	estraibile

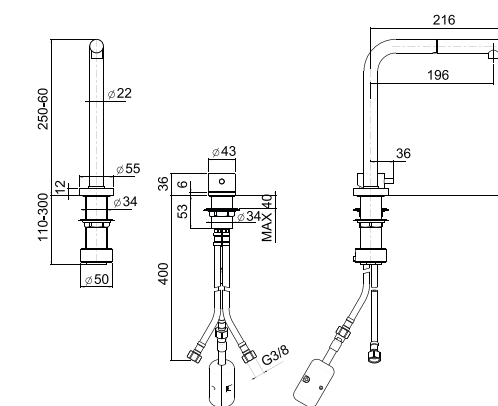
Cod. **SS 02802**

ARIAL STEEL



59

Materiale	Acciaio inox AISI 316 L
Finitura	Spazzolato
Rotazione canna	360°
Foro installazione	Ø 35 mm
Cartuccia	disco ceramico
Doccetta	estraibile

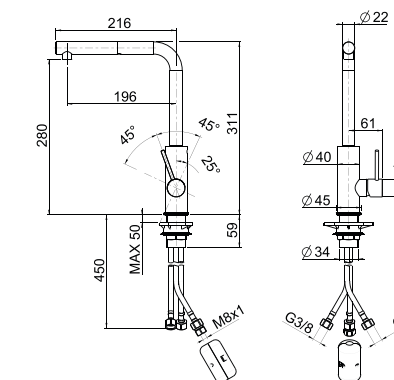
Cod. **SS 02820**

COMPLEMENTI

PILETTE E TROPPOPIENI



PLUS –
SATINATO

Cod. **SS 02608**



STANDARD –
SATINATO

Cod. **SS 02740**



BLACK –
NERO OPACO

Cod. **SS 02741**



ECLISSE –
SATINATO

Permette il deflusso.
Compatibile con pilette
tonde ø 3,5”.

Cod. **SS 02748**

PILETTE E TROPPOPIENI TITANIUM



PLUS –
GUN METAL

Cod. **SS 02717**



PLUS –
COPPER BRONZE

Cod. **SS 02716**



PLUS –
PALE GOLD

Cod. **SS 02715**

PILETTE AUTOMATICHE



SALTARELLO – PLUS

Azionamento a pressione.

Cestello e pulsante comando satinati.

Cod. **SS 02744**



SALTARELLO – STANDARD

Azionamento a pressione.

Cestello e comando satinati.

Cod. **SS 02742**



SALTARELLO – BLACK

Azionamento a pressione. Cestello e
pulsante comando in nero opaco.

Cod. **SS 02743**



PILETTE AUTOMATICHE TITANIUM



SALTARELLO – PLUS

Gun Metal – Azionamento a pressione.

Cestello e pulsante comando in PVD.

Cod. **SS 02747**



SALTARELLO – PLUS

Copper Bronze – Azionamento
a pressione. Cestello e pulsante
comando in PVD.

Cod. **SS 02746**



SALTARELLO – PLUS

Pale Gold – Azionamento a pressione.
Cestello e pulsante comando in PVD.

Cod. **SS 02745**



SIFONI



Attacco salvaspazio per lavelli a uno scarico; con attacco per lavastoviglie.

Cod. **Una Via** **SS 00448**

Cod. **Due Vie** **SS 00449**

DISSIPATORE ALIMENTARE



In acciaio spazzolato, permette il deflusso.

Compatibile con pilette tonde 3 ½".

Titanium e Matte Vintage non disponibili.

Cod. **TRFWD 60T**

CURA DELL'ACCIAIO INOX



PULIZIA - KIT COMPLETO

- Crema detergente (flacone da 250 ml)

- Panno per pulizia

- Panno di finitura

Cod. **SS 01751**

Cod. **SS 02771** [12 Conf.]



CREMA DETERGENTE

Specifica per la pulizia dell'acciaio inox - flacone da 250 ml.

Cod. **SS 02772** [12 Pz.]



PANNO ANTIBATTERICO

In microfibra per finiture

- dimensione 40x40 cm.

Confezione da 3 pezzi.

Cod. **SS 02774** [12 Conf.]

I lavelli workstation di ARTINOX sono realizzati in acciaio inox AISI 304 18/10 (EN 1.4301), una lega di acciaio al cromo e nichel. L'acciaio inox è il materiale igienico per eccellenza, tenace e molto resistente alla corrosione, il prodotto ideale per il contatto con gli alimenti. Tutti gli articoli ARTINOX sono realizzati rispettando i più severi standard qualitativi e testati uno ad uno.

AVVERTENZE

Come tutti i materiali anche l'acciaio inox richiede una cura regolare ed una pulizia quotidiana. L'uso improprio può danneggiare la superficie anche in modo permanente.

I seguenti consigli proteggono il lavello dai danni causati dalla corrosione di detersivi non idonei alla pulizia.

PULIZIA

Per la pulizia quotidiana consigliamo di strizzare una spugna dall'acqua calda e bagnarla con aceto bianco.

Per una pulizia profonda utilizzare SOLO prodotti ufficiali Artinox, acquistabili presso i rivenditori autorizzati o consultando www.artinox.com.

MANTENIMENTO

Dopo ogni uso, pulire, risciacquare ed asciugare accuratamente il lavello con un panno morbido. NON lasciare detersivi e prodotti per la pulizia a lungo a contatto con la superficie.

NON utilizzare acido cloridrico, acido fluoridrico, acido fosforico, candeggina, ammoniaca, o detersivi che contengono anche minime dosi tali sostanze.

NON utilizzare spugne, detersivi e creme abrasive.

NON lasciare oggetti, metalli ferrosi e non ferrosi all'interno del lavello.

CONDIZIONI GENERALI DI VENDITA

Come ordinare:

Si accettano solo ordini scritti e completi. L'ordine dovrà indicare i codici delle singole parti come nel presente listino indicati. Seguirà nostra conferma d'ordine che si intende corretta ed accettata se non contestata entro 3 giorni dalla data di invio a mezzo posta elettronica, fax. La società Artinox S.p.A. si riserva la facoltà, qualora si rendesse opportuno, di variare, modificare e/o annullare, i prodotti, le misure, le descrizioni, i prezzi indicati sul presente listino in qualsiasi momento senza bisogno di alcun preavviso e ciò senza possibilità di rivendicazioni da parte dell'acquirente.

Consegna:

I termini di consegna sono indicativi e si intendono in condizioni normali di lavoro e sono presso l'Artinox. In nessun caso potrà essere richiesto alla venditrice il rimborso per eventuali danni per ritardata consegna, né il ritardo può costituire motivo di rescissione del contratto. L'acquirente ha infatti rinunciato a far valere ogni domanda, azione ed eccezione in ordine a tali ipotesi. La verifica della qualità e del tipo di merce deve essere fatta dal compratore alla consegna.

Resa:

franco nostro stabilimento di Conegliano (Treviso) Italia. La merce viaggia a rischio e pericolo dell'acquirente anche nei casi in cui il prodotto, per accordi diversi, sia reso franco destino.

Imballo:

Imballo standard in scatole di cartone gratuite o con imballo adeguato è compreso nel prezzo. Imballi speciali verranno addebitati al costo.

Prezzi:

I prezzi del presente listino non comprendono: i.v.a., trasporto, imballi speciali, oneri doganali, gabbie e/o bancali in legno, montaggio e collaudo.

Condizioni di pagamento:

Da convenire. Tutti gli oneri relativi al pagamento di commissioni bancarie, bolli, ecc. saranno addebitati in fattura. Nel caso di ritardi di pagamenti, l'azienda si riserva il diritto di sospendere la consegna degli ordini in corso, senza obbligo di alcuna comunicazione. Le parti espressamente convengono che l'acquirente acquisterà la proprietà del materiale all'atto del pagamento integrale del prezzo complessivo concordato, oltre gli accessori, ma ne assumerà i rischi dal momento della consegna ex art. 1523 c.c. In seguito alla scadenza dei termini concordati dalle parti per il pagamento del materiale, nessun reclamo riguardante la qualità della merce potrà essere fatto valere, neppure in via d'eccezione, in sede giudiziaria, se regolare pagamento alla quale il reclamo si riferisce non avrà ancora avuto luogo.

Interessi di mora:

Il ritardato pagamento comporta automaticamente, senza pertanto bisogno di particolari diffide, l'addebito degli interessi di mora 1,5% mensile dal giorno successivo di scadenza del pagamento indicato in fattura. Saranno addebitate, inoltre, tutte le spese sostenute per il recupero delle somme dovute.

Garanzia:

La garanzia è di 24 mesi dalla data di spedizione e si intende sulle singole parti. Il venditore non risponde dei danni diretti e/o indiretti provocati dalle e/o alle attrezzature, impianti, persone per uso improprio o colposo delle stesse, per urti, per installazione non corretta, per utilizzazione fuori tolleranza.

Tutti i difetti visivi quali botte, graffi, macchie o rotture devono essere tassativamente segnalati prima dell'installazione e/o utilizzo. Le difettosità riportate sopra saranno escluse dalla garanzia qualora venissero segnalate successivamente all'installazione poiché non riconducibili a difetti di origine.

I pezzi difettosi dovranno essere resi, previa autorizzazione scritta della Artinox, franco stabilimento di Conegliano (Treviso) Italia e saranno sostituiti in garanzia solo dopo verifica. I pezzi riconosciuti difettosi saranno sostituiti e spediti franco destino a mezzo corriere. La garanzia non copre i costi relativi alla sostituzione del pezzo, è valida soltanto nei confronti dell'acquirente originario.

Ogni articolo in questo catalogo è prodotto in conformità alle normative vigenti e alle direttive CE. Tutti i dati riportati non sono vincolanti.

Artinox S.p.a. si riserva la facoltà di apportare modifiche ritenute utili al miglioramento della propria offerta in qualsiasi momento, senza preavviso e declinando ogni responsabilità per eventuali errori o inesattezze.

La riproduzione delle colorazioni a catalogo sono da ritenersi indicative.

Sono vietate le riproduzioni nel suo insieme o in parte del presente catalogo, senza la specifica autorizzazione scritta di Artinox S.p.a.

© Copyright 2024 Artinox S.p.a. - Tutti i diritti riservati.

Edizione 3 - Giugno 2024

CONCEPT

Artinox S.p.A.

GRAPHIC DESIGN

Marta Amistani – Topvisualbeauty.com

PHOTOGRAPHY

Michele Salucci – Immaginarìa Srl

PRINT

Grafiche Antiga

100 %
MADE IN
ITALY

